

**ANNEX 11**

**RESOLUTION MEPC.122(52)**

**Adopted on 15 October 2004**

**EXPLANATORY NOTES ON MATTERS RELATED TO THE ACCIDENTAL  
OIL OUTFLOW PERFORMANCE UNDER REGULATION 23 OF THE REVISED  
MARPOL ANNEX I**

THE MARINE ENVIRONMENT PROTECTION COMMITTEE,

RECALLING Article 38(a) of the Convention on the International Maritime Organization concerning the functions of the Marine Environment Protection Committee (the Committee) conferred upon it by international conventions for the prevention and control of marine pollution,

NOTING resolution MEPC.117(52) by which the Committee adopted the revised Annex I of MARPOL 73/78 which, in its regulation 23, contains provisions related to the oil outflow performance,

NOTING ALSO that the Marine Environment Protection Committee, in considering the above amendments, recognized the necessity of development of appropriate explanatory notes for implementation of the regulations adopted, in order to ensure their uniform application,

HAVING CONSIDERED the recommendation made by the Sub-Committee on Bulk Liquids and Gases at its eighth session,

1. ADOPTS the Explanatory notes on matters related to the accidental oil outflow performance under regulation 23 of the revised MARPOL Annex I, the text of which is set out in the Annex to the present resolution;
2. INVITES Member Governments to give due consideration to the Explanatory notes when implementing the requirements prescribed in regulation 23 of the revised MARPOL Annex I;
3. AGREES to keep the Explanatory notes under review in the light of experience gained;
4. INVITES the Maritime Safety Committee to note the Guidelines; and
5. URGES Member Governments to bring the aforementioned Explanatory notes to the attention of shipbuilders, shipowners, ship operators and other parties concerned with the design, construction and operation of oil tankers.

## ANNEX

### **EXPLANATORY NOTES ON MATTERS RELATED TO THE ACCIDENTAL OIL OUTFLOW PERFORMANCE UNDER REGULATION 23 OF THE REVISED MARPOL ANNEX I**

#### **PART A - BACKGROUND**

##### **1 Introduction**

1.1 Under resolution MEPC.51(32), the Marine Environment Protection Committee (MEPC) adopted, at its thirty-second session, amendments to Annex I of the MARPOL 73/78 Convention. The key issues of these amendments were the then new MARPOL Annex I regulations 13F and 13G, which address the prevention of oil pollution in the event of collision or stranding. MARPOL Annex I regulation 13G, which covered the treatment of existing tankers, will not be discussed in this paper. MARPOL Annex I regulation 13F addressed oil tanker newbuildings and contained the double-hull requirements applicable to oil tanker newbuildings, for which the building contract is placed on or after 6 July 1993.

1.2 Paragraph (4) of MARPOL Annex I regulation 13F addressed the so called “mid-deck design”, which means that the protective double-bottom ballast tanks may be dispensed with, if a horizontal partition (“mid-deck”) is fitted in such a way that the internal cargo pressure plus vapour pressure is less than the external sea water pressure. This is called the hydrostatic balance principle.

1.3 By means of the IMO comparative study on oil tanker design (OTD)<sup>(1)\*</sup> it was demonstrated that the oil outflow performance of mid-deck tankers is at least equivalent to that of double-hull tankers, but it was recognized that within this overall conclusion each design gives better or worse oil outflow performance under certain conditions.

1.4 It was therefore recognized early by the MEPC that there is a compelling need for IMO to establish internationally agreed guidelines for the assessment of the oil outflow performance of alternative tanker designs in relation to basic double-hull designs. This intent was expressed in paragraph (5) of MARPOL Annex I regulation 13F as follows:

“(5) Other methods of design and construction of oil tankers may also be accepted as alternatives to the requirements prescribed in paragraph (3)<sup>1</sup>, provided that such methods ensure at least the same level of protection against oil pollution in the event of collision or stranding and are approved in principle by the Marine Environment Protection Committee based on guidelines developed by the Organization<sup>2</sup>.”

---

\* Refers to reference (1) on page 43.

<sup>1</sup> Regulation 13F(3) contained the double hull requirements.

<sup>2</sup> It is worthwhile to note that IMO reserves the right for the approval in principle of any new design and that this is not left to the discretion of a national administration. This was done in order to ensure uniform assessment of such alternatives.

1.5 Interim guidelines were adopted in September 1995. They were included as per Appendix 7 to MARPOL Annex I as “Interim Guidelines”. The word “interim” expresses the intent to update the Interim Guidelines when experience had been gained during a three to four years application period. The Interim Guidelines were superseded by the Revised Interim Guidelines, which were adopted by resolution MEPC.110(49) in 2003.

1.6 The calculation methodology prescribed in the Revised Interim Guidelines involves direct application of the provided probability density functions (PDFs) to the design. As there are five probability density functions (pdfs) for side and bottom damage this is a calculation-intensive approach.

1.7 Following this development, the MEPC considered it necessary to reconsider and revise the existing MARPOL Annex I regulations 22 through 24, which covered a similar issue, i.e. minimizing oil pollution from oil tankers due to side and bottom damages, in a more traditional (deterministic) manner. It was recognized that the existing deterministic regulations did not properly account for variations in subdivision in general, and longitudinal subdivision in particular. Therefore, the accidental oil outflow performance regulation 23 was developed for the revised MARPOL Annex I. The envisaged goal was to provide a performance based accidental oil outflow regulation that effectively handles variations in subdivision. This regulation is made consistent with the Revised Interim Guidelines to avoid the possibility of contradictions in acceptability of oil pollution prevention regulations due to their difference in nature.

1.8 While it was felt that the rigorous approach prescribed by the Revised Interim Guidelines was suitable for the evaluation of alternative tanker designs and possible unique tank-configurations, a less complex regulation was considered necessary for application to all tankers. Thus, a “simplified” method based on the same background was developed. These explanatory notes describe the assumptions and philosophy underlying this simplified approach for assessing oil outflow, provide background on the development of the performance index, and contain examples demonstrating application of this regulation.

1.9 This simplified method based on minimum clearances between the cargo tanks and the hull is suitable for tank arrangements. For certain designs such as those characterized by the occurrence of steps/recesses in decks and for sloping bulkheads and/or a pronounced hull curvature, more rigorous calculations may be appropriate.

1.10 Combination carriers are ships designed and built for carrying both dry and liquid cargo (i.e. bulk cargo and oil cargo). Traditionally these ships are built without any centreline bulkhead. The new probabilistic method is suitable also for the combination carriers, but due to the nature of the design they may not be able to comply with the outflow performance index (mean outflow parameter) of a standard oil tanker. For combination carriers, separate mean oil outflow parameter may be applied provided it is demonstrated by calculations that the increased structural strength of the hull is providing for improved environmental protection compared to a standard double hull oil tanker of the same size. The calculations are to be to the satisfaction of the Administration.

## 2 Overview of the methodology

2.1 There are three basic steps involved when applying this regulation:

- .1 determine the probability of penetrating each oil tank within the cargo block length, for both side damage (collisions) and bottom damage (strandings);
- .2 assess the expected oil outflow from each damaged oil tank; and
- .3 compute the mean outflow parameter and compare to the specified maximum permissible value.

2.2 This approach differs from the Revised Interim Guidelines <sup>(2)\*</sup>, which calls for calculation of three separate outflow parameters: the probability of zero oil outflow, the mean outflow, and the extreme oil outflow.

- .1 the *probability of zero outflow*,  $P_0$ , represents the likelihood that no oil will be released into the environment, given a collision or grounding casualty which breaches the outer hull.  $P_0$  equals the cumulative probability of all damage cases with no outflow;
- .2 the *mean outflow parameter*,  $O_M$ , is the non-dimensionalized mean or expected outflow, and provides an indication of a design's overall effectiveness in limiting oil outflow. The mean outflow equals the sum of the products of each damage case probability and the associated outflow.  $O_M$  equals the mean outflow divided by the total quantity of oil onboard the vessel; and
- .3 the *extreme outflow parameter*,  $O_E$ , is the non-dimensionalized extreme outflow, and provides an indication of the expected oil outflow from particularly severe casualties. The extreme outflow is the weighted average of the upper 10% of all casualties (i.e. all damage cases within the cumulative probability range from 0.9 to 1.0).

2.3 In accordance with the Revised Interim Guidelines, the parameters are combined using the following formula, in order to provide an overall assessment of a design's outflow performance in the event of a collision or grounding.  $P_0$ ,  $O_M$ , and  $O_E$  are the oil outflow parameters for the alternative design, and  $P_{OR}$ ,  $O_{MR}$ , and  $O_{ER}$  are the oil outflow parameters for the reference ship of equivalent size. The pollution prevention index "E" must be greater than or equal to 1.0, for a design to be considered equivalent to the reference ship.

$$E = \frac{(0.5)(P_0)}{P_{OR}} + \frac{(0.4)(0.01 + O_{MR})}{0.01 + O_M} + \frac{(0.1)(0.025 + O_{ER})}{0.025 + O_E} \quad (2.3)$$

2.4 Application of the Revised Interim Guidelines requires determination of the probability of occurrence and oil outflow for each unique damage case. For a typical tanker, this involves assessment of thousands of damage conditions. These data are then applied when computing the three outflow parameters.

2.5 A significant difference between regulation 23 and the Revised Interim Guidelines is in the assessment of damage cases. Rather than determining each unique damage case and its

---

\* Refers to reference (2) on page 43.

associated probability, the probability of damaging each oil tank within the cargo block length is calculated. This equals the probability that an oil tank will be breached, either alone or in combination with other tanks, and equals the sum of the probabilities for all of the unique damage cases which involve that particular oil tank.

2.6 The simplified probabilistic calculation method as applied in this regulation is based on the following principle:

$$\text{Mean Outflow} = \sum_i(p_i v_i) = \sum_j(p_j v_j) \quad (2.6)$$

where:

$p_i$  = probability of occurrence of damage scenario  $i$  (where one cargo tank or a group of adjacent tanks may be involved)

$v_i$  = volume of oil outflow from cargo tanks involved in damage scenario  $i$  under consideration

$i$  = subscript denoting the damage scenario under consideration

$p_j$  = probability of occurrence that cargo tank  $j$  is damaged (irrespective of the damage scenarios involved)

$v_j$  = volume of oil outflow from cargo tank  $j$

$j$  = subscript denoting the cargo tank under consideration

$\Sigma$  = symbol for the summation to be carried out over all possible damage scenarios  $i$  or cargo tanks  $j$  respectively resulting in a non-zero contribution to the mean oil outflow

2.7 The mean outflow parameter,  $O_m$ , equals the mean outflow divided by the total oil onboard,  $C$ . For regulation 23 as well as the Revised Interim Guidelines,  $C$  is defined as the total cargo oil capacity at 98% tank filling.

2.8 Because the unique damage cases are not determined, calculation of the probability of zero outflow and extreme outflow are not practical with this simplified approach. In regulation 23, the mean outflow parameter alone is used to assess the outflow performance. Of the three parameters, mean outflow performance is considered to be the best indicator of overall outflow performance.

2.9 This is considered a reasonable simplification, as each design must also meet the provisions of regulation 19. It is assumed that the double hull provisions of regulation 19 and the more rigorous analytical approach contained in the Revised Interim Guidelines assures that the design provides adequate protection against the likelihood of spills, as is measured by the probability of zero outflow parameter. The extreme oil outflow parameter provides an indication of the expected oil outflow from particularly severe casualties. To a large extent, the impact of large spills is reflected in the mean outflow parameter, as it represents the weighted average of all spills.

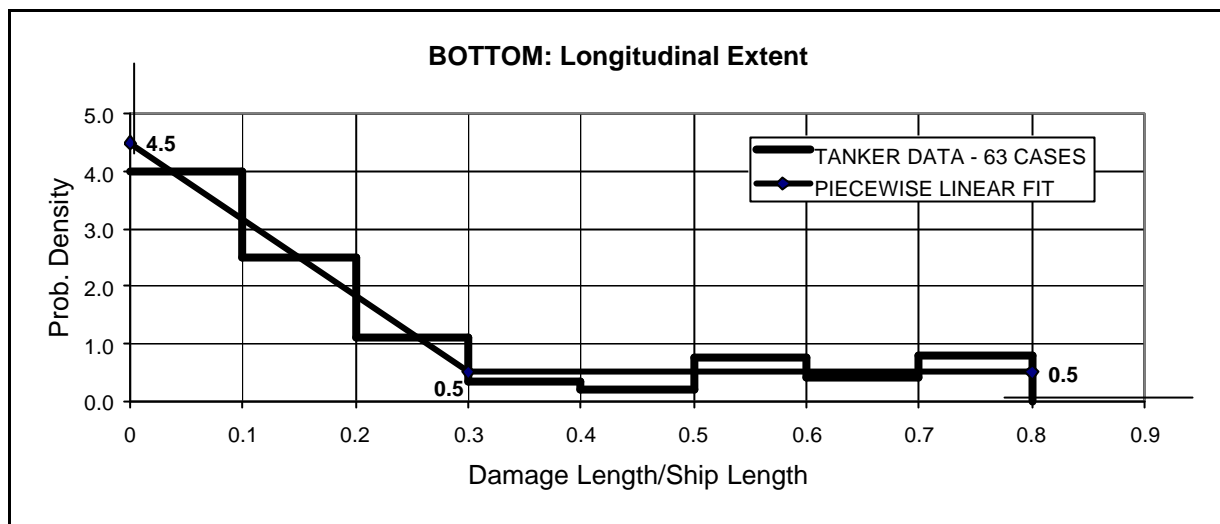
### 3 The probability density functions (pdf's)

3.1 The Revised Interim Guidelines contain probability density functions (pdf's) describing the location, extent and penetration of side and bottom damage. These functions were derived from historical damage statistics for 52 collisions and 63 groundings, compiled by the classification societies at IMO's request <sup>(2)\*</sup>. These statistics were derived from casualties to oil tankers, chemical tankers, and combination carriers of 30,000 tonnes deadweight and above, for the period 1980 to 1990.

---

\* Refers to reference (2) on page 43.

3.2 Figure 1 shows the statistic data and piecewise linear probability density function, representing the longitudinal extent of damage when subject to bottom damage. Other forms of curve fitting such as beta distributions were also considered. However, they were found to have little impact on the overall analysis, and therefore the easier to apply piecewise linear fit was adopted for the Revised Interim Guidelines.



**Figure 1 – Histogram and Probability Density Function:  
 Longitudinal Extent of Bottom Damage**

3.3 Side damage pdf's as shown in figures 2 through 6 provide the probability of damage as a function of:

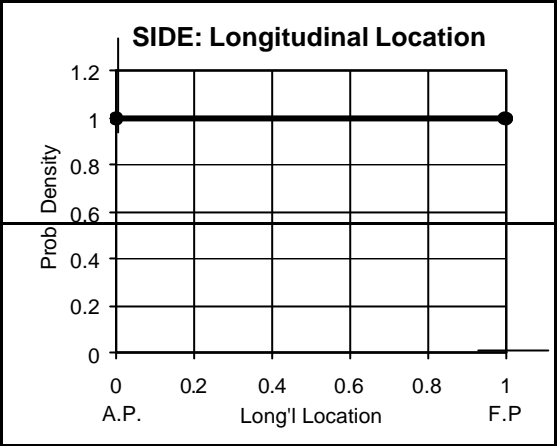
- Longitudinal location
- Longitudinal extent
- Vertical location
- Vertical extent
- Transverse penetration

3.4 Bottom damage pdf's as shown in figures 7 through 11 provide the probability of damage as a function of:

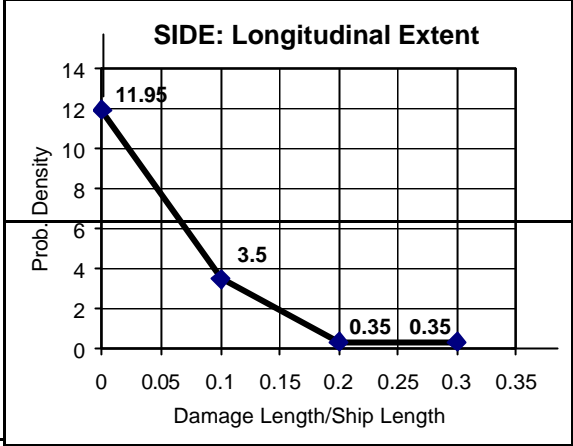
- Longitudinal location
- Longitudinal extent
- Transverse location
- Transverse extent
- Vertical penetration

3.5 The density scales are normalized by the ship length for longitudinal location and extent, by ship breadth for transverse location and extent, and by ship depth for vertical location and extent. The pdf variables are treated independently for the lack of adequate data to define their dependency.

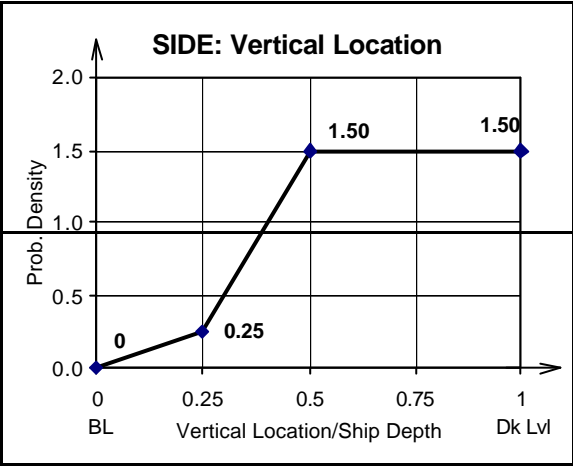
3.6 These functions are based on limited statistics consisting of damages to largely single-hulled tankers. These statistics should be periodically reviewed as new data becomes available.



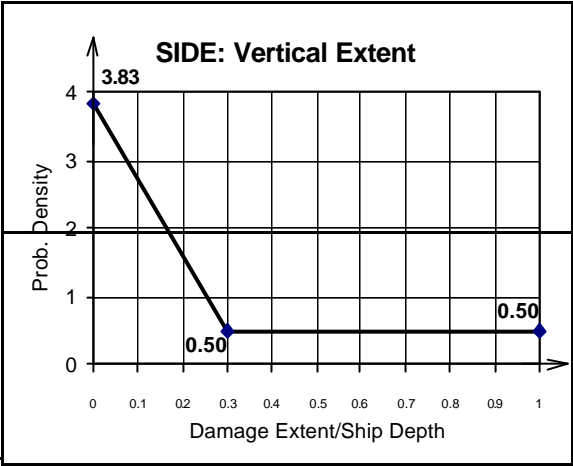
**Figure 2: Side Damage: Longitudinal Location**



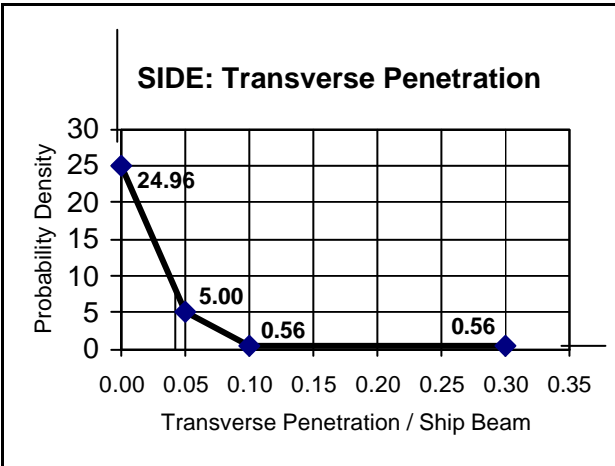
**Figure 3 - Side Damage: Longitudinal Extent**



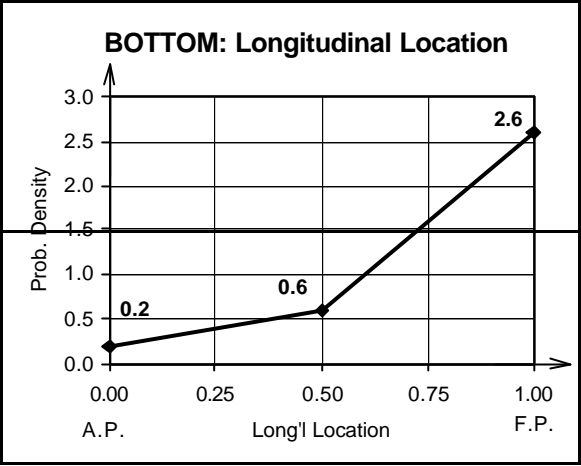
**Figure 4 - Side Damage: Vertical Location**



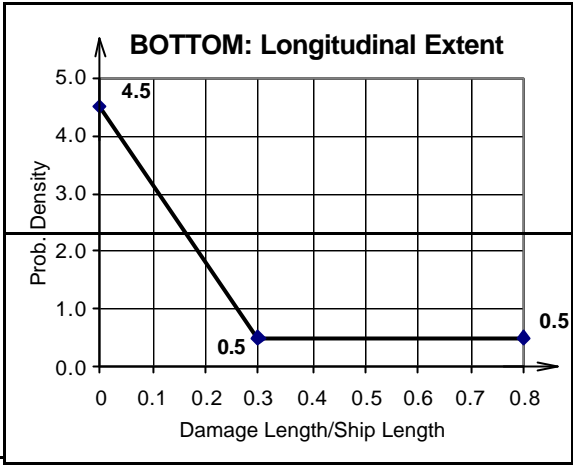
**Figure 5 - Side Damage: Vertical Extent**



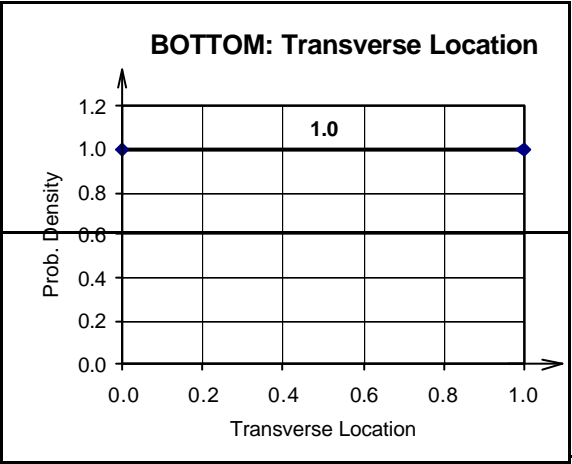
**Figure 6 - Side Damage: Transverse Penetration**



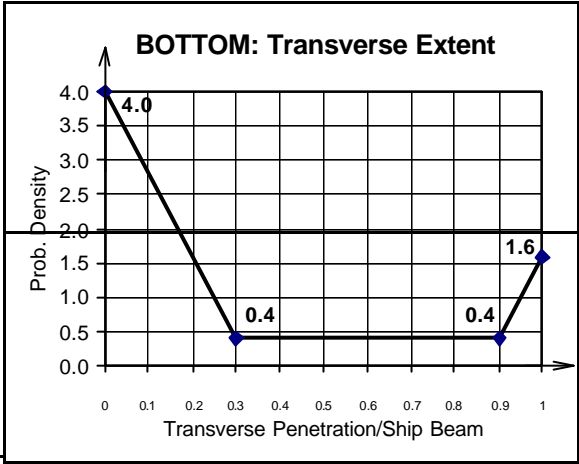
**Figure 7 - Bottom Damage:  
 Longitudinal Location**



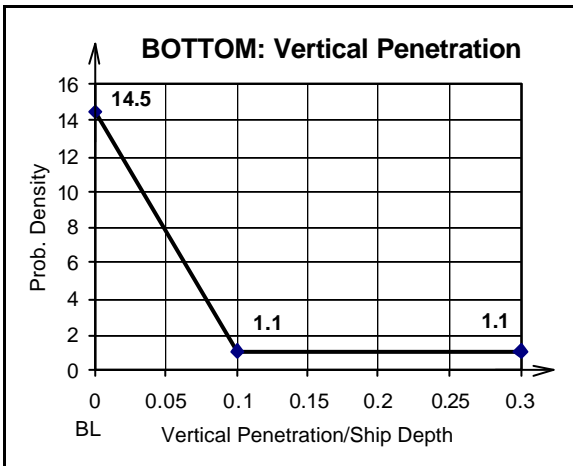
**Figure 8 - Bottom Damage:  
 Longitudinal Extent**



**Figure 9 - Bottom Damage:  
 Transverse Location**



**Figure 10 - Bottom Damage:  
 Transverse Extent**



**Figure 11 - Bottom Damage:  
 Vertical Penetration**



#### 4 The tables of probability for side and bottom damage

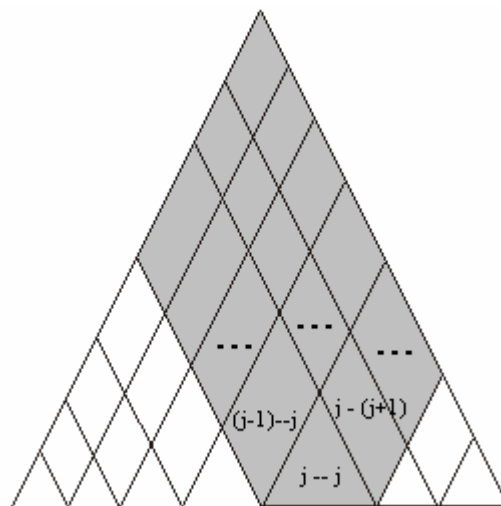
4.1 To ease application of the probability density functions, the probability density distributions for damage location, extent, and penetration have been converted into a set of tables and simple equations. These tables indicate the probability that the damage is bounded on one side by a given longitudinal, transverse or horizontal plane.

4.2 For example, the function  $p_b(d)$  is the probability that damage is restricted to less than  $d$ , the normalized damage location, given  $g(y)$ , the probability density distribution of extent of damage,  $h(x)$ , the probability density distribution of location, and  $c$ , the maximum extent of damage. Similarly,  $p_a(d)$  is the probability that damage is restricted to more than  $d$ .

$$p_b = \int_0^c \int_0^{d-y/2} g(y) \cdot h(x) dx dy \quad (4.2-1)$$

$$p_a = \int_0^c \int_{d+y/2}^1 g(y) \cdot h(x) dx dy \quad (4.2-2)$$

4.3 These equations are repeated for all of the damage probability calculations. For the cases involving penetration they simplify to single integral equations. For the cases involving both extent and location, special consideration must be given to the ends of the density. The functions define the damage location as the centre of damage. Damage zones towards the ends or sides of the ship can span beyond the vessel. This explains why all the probability tables do not extend to 1.00.



**Figure 12 - Integration Region for Integrated Damage Probability  $P_j$  of  $j$ -th Tank**

4.4 To obtain the probability that a region bounded by  $d_1$  below and  $d_2$  above is damaged, one finds  $p = 1 - p_b(d_1) - p_a(d_2)$ . Note that this probability includes all damages which include the region, not just those that damage that region alone. To determine the probability of damage for a region in three-dimensional space the appropriate probabilities in each dimension are multiplied together reflecting the independence between the pdfs. To simplify the calculation process each three dimensional region is modelled as an equivalent rectilinear block described by six boundaries.

4.5 The tables and equations for side damage provide the following parameters:

$P_{Sa}$  = the probability the damage will lie entirely aft of location  $X_a/L$ ;  
 $P_{Sf}$  = the probability the damage will lie entirely forward of location  $X_f/L$ ;  
 $P_{Sl}$  = the probability the damage will lie entirely below the tank;  
 $P_{Su}$  = the probability the damage will lie entirely above the tank; and  
 $P_{Sy}$  = the probability the damage will lie entirely outboard of the tank.

4.6 The tables and equations for bottom damage provide the following parameters:

$P_{Ba}$  = the probability the damage will lie entirely aft of location  $X_a/L$ ;  
 $P_{Bf}$  = the probability the damage will lie entirely forward of location  $X_f/L$ ;  
 $P_{Bp}$  = the probability the damage will lie entirely to port of the tank;  
 $P_{Bs}$  = the probability the damage will lie entirely to starboard of the tank; and  
 $P_{Bz}$  = the probability the damage will lie entirely below the tank.

## 5 The probability of penetrating a cargo oil tank

5.1 The probability,  $P_S$ , of breaching a given cargo oil tank subject to side damage is computed as follows:

$$P_S = (1 - P_{Sf} - P_{Sa})(1 - P_{Su} - P_{Sl})(1 - P_{Sy}) \quad (5.1)$$

$(1 - P_{Sf} - P_{Sa})$  is the probability that the damage will penetrate into the longitudinal zone defined by transverse planes located at the extreme fore and aft bounds of the tank.  $(1 - P_{Su} - P_{Sl})$  is the probability that the damage will penetrate into the vertical zone defined by horizontal planes located at the extreme upper and lower bounds of the tank.  $(1 - P_{Sy})$  is the probability that the transverse extent of damage will penetrate into the zone defined by the outboard bulkhead of the tank.

5.2 Similarly, the probability  $P_B$ , of breaching a given cargo oil tank subject to bottom damage is computed as follows:

$$P_B = (1 - P_{Bf} - P_{Ba})(1 - P_{Bp} - P_{Bs})(1 - P_{Bz}) \quad (5.2)$$

$(1 - P_{Bf} - P_{Ba})$  is the probability that the damage will penetrate into the longitudinal zone defined by transverse planes located at the extreme fore and aft bounds of the tank.  $(1 - P_{Bp} - P_{Bs})$  is the probability that the damage will penetrate into the transverse zone defined by vertical planes parallel to centreline, located at the extreme port and starboard most bounds of the tank.  $(1 - P_{Bz})$  is the probability that the vertical extent of damage will extend into the zone defined by the bottom of the tank.

5.3 The extreme boundaries of each compartment are applied when determining the dimensions of the rectilinear block. Although the averaging of sloping boundaries was investigated, it was found that application of the extreme boundaries generally provided more consistent and usually slightly conservative results as compared to the more rigorous procedures discussed in paragraph 10 of regulation 23.

## 6 Calculation of mean outflow from side damage

6.1 There were no available data on the percentage of outflow from a tank subject to side damage, and theoretical calculation of the portion of retained liquid was considered impractical. Therefore, it is conservatively assumed that for side damage, total (100%) of the oil outflows from each damaged cargo tank. This is consistent with the approach applied in the Revised Interim Guidelines.

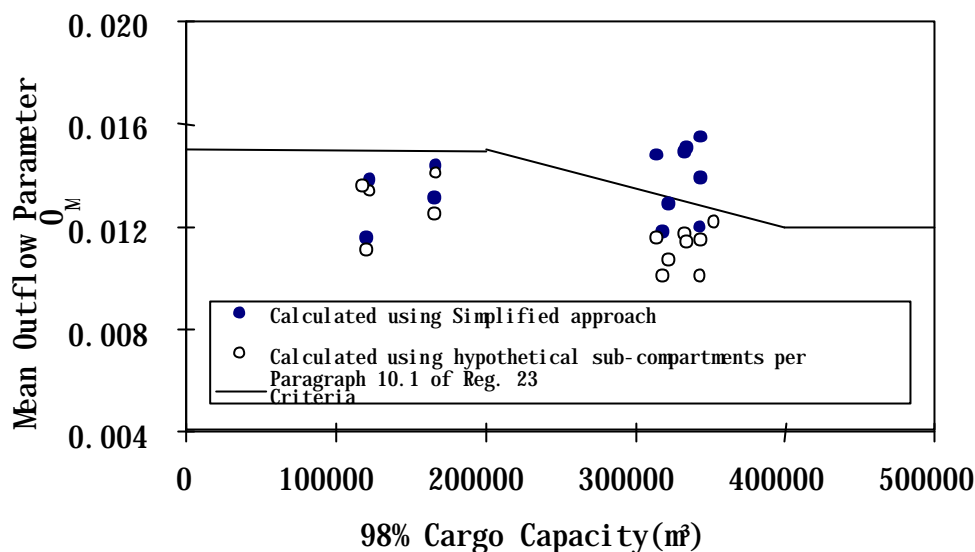
6.2 In accordance with paragraph 6 of regulation 23, the mean outflow from side damage is calculated as follows:

$$O_{MS} = C_3 \sum_i^n P_{s(i)} O_{s(i)} \text{ (m}^3\text{)} \quad (6.2)$$

Where  $P_{s(i)}$  is the probability of penetrating cargo tank  $i$  from side damage, and  $O_{s(i)}$  is the outflow from side damage to cargo tank  $i$ .

6.3 In accordance with the simplified approach prescribed in regulation 23, the probability that damage will extend transversely into a cargo tank is calculated based on the minimum horizontal distance between the compartment and the side shell. Where the distance to the shell is not uniform, this assumption will result in over-estimates of oil outflow. This is most evident in way of the forward and aft cargo tanks, where hull curvature is most pronounced.

6.4 More rigorous calculations carried out to validate the methodology showed that tankers with two continuous longitudinal bulkheads within the cargo tanks (i.e. with a three across cargo tank arrangement) are most affected by this conservative approach. Figure 13 presents the mean outflow parameters for a series of tankers calculated using the simplified approach as per regulation 23 without consideration of the  $C_3$  factor, and also calculated based on the hypothetical sub-compartment methodology specified in paragraph 10.1 of regulation 23. The vessels with capacities of under 200,000 m<sup>3</sup> which have a single centreline bulkhead show good correspondence. The simplified regulation 23 approach overestimates the outflow performance of vessels over 300,000 m<sup>3</sup> capacity, all of which have two longitudinal bulkheads within the cargo tanks. Therefore, in the case of such designs the outflow from side damage is multiplied by the  $C_3$  factor 0.77.



**Figure 13 – Comparison of calculations using the simplified method and hypothetical sub-compartments**

## 7 Calculation of mean outflow from bottom damage

7.1 For bottom damage, oil loss is calculated based on the pressure balance principle.

7.2 In accordance with paragraph 7 of regulation 23, for a given tidal condition the mean outflow from bottom damage is calculated as follows:

$$O_{MB(0)} = \sum_i^n P_{B(i)} O_{B(i)} C_{DB(i)} \quad (m^3) \quad (7.2)$$

7.3 As explained below, the factor  $C_{DB(i)}$  accounts for oil entrapped within non-cargo tanks located immediately below a cargo tank.

7.4 Independent calculations are carried out for zero and minus 2.5 m tide conditions and the outflow values are then combined as follows:

$$O_{MB} = 0.7 O_{MB(0)} + 0.3 O_{MB(2.5)} \quad (m^3) \quad (7.4)$$

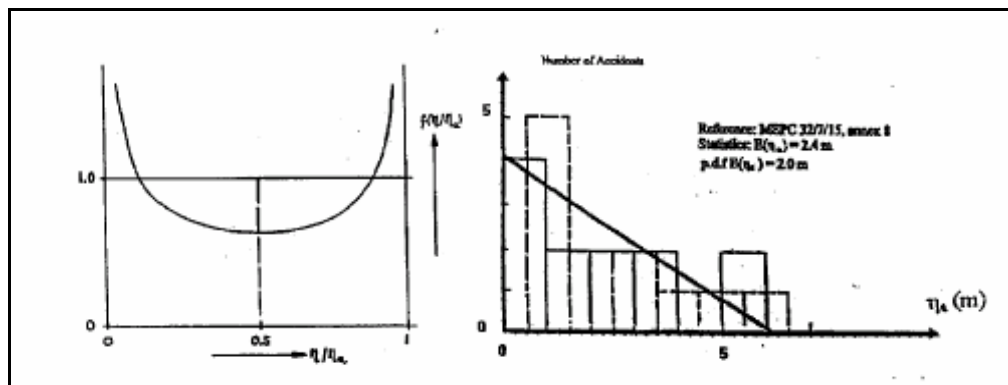
### 7.5 Tidal Effects

7.5.1 When an oil tanker experiences bottom damage as a result of a stranding and remains aground, the occurrence of a fall of tide may result in an outflow of oil because of the hydrostatic balance principle. For this regulation, oil loss is calculated assuming tide reductions of 0 and 2.5 metres.

7.5.2 The random nature of the fall of tide may be described by the following two probability density functions:

- .1 probability density function of relative fall of tide assuming that the tidal motion may be represented with sufficient accuracy by a long-periodical harmonic motion and that the time dependent probability of occurrence of a grounding accident is uniformly distributed over the tidal period. The relative fall of tide is defined as the ratio of the actual fall of tide and the double amplitude of the tidal motion.

- .2 probability density function of the double amplitude of tidal motion at the time of the accident. From the statistics, which are restricted to data available from the OTD study [1], an approximate analytical description of the probability density function can be estimated.



**Figure 14 – Histogram and Probability Density Function:  
Fall of Tide**

7.5.3 From these two probability density functions the probability density function of the actual fall of tide may be derived. Although extreme tides of 6 m or more occur in certain areas of the world, such large tides are relatively rare. The probability density function for the fall of tide shows a significant effect up to about 3 m. That is, the probability of an actual fall in tide in excess of 3 m is less than 5%.

7.5.4 There is also a reduced probability that vessels will ground at high tide, as under keel clearances are typically increased.

7.5.5 It was determined that the tidal effect could be reasonably represented by performing calculations at two tides, 0 m and –2.5 m and then combining the results by 70%:30% ratio.

## 7.6 Cargo tanks bound by the bottom shell

7.6.1 Even if they are in hydrostatic balance, some cargo oil outflow can be expected from cargo tanks bounding the bottom shell which are penetrated due to bottom damage. These losses are attributable to initial exchange losses occurring on impact, and dynamic effects introduced from current and waves.

7.6.2 For the OTD study <sup>(1)\*</sup>, model tests were carried out for the purpose of assessing the magnitude of these dynamic losses. For the purposes of that study, it was decided that oil outflow equal to at least 1% of the cargo tank volume should be assumed. This same assumption is applied in the Revised Interim Guidelines as well as regulation 23.

## 7.7 Oil retained in non-oil tanks located below the cargo tank

7.7.1 When a double hull tanker experiences bottom damage through the double bottom tanks and into the cargo tanks, a certain portion of the oil outflow from the cargo tanks may be entrapped in the double bottom tanks. Where the pressure differential between the cargo in the tank and the outside sea is small (e.g. during a falling tide), it is reasonable to assume that the

\* Refers to reference (1) on page 43.

double hull space will be very effective in retaining lost oil. However, when the pressure differential is relatively large and the penetration small, model tests conducted during the OTD study <sup>(1)\*</sup> demonstrated that only about 1/7 of the oil flowing out was retained in the double hull spaces.

7.7.2 As a consequence of these studies, it was surmised that “if both outer and inner bottoms are breached simultaneously and the extent of rupture at both bottoms is the same, it is probable that the amount of seawater and oil flowing into the double hull space would be the same.” On this basis, the Revised Interim Guidelines specify that for breached non-cargo spaces located wholly or in part below breached cargo oil tanks, the flooded volume of these spaces at equilibrium should be assumed to contain 50% oil and 50% seawater by volume, unless proven otherwise.

7.7.3 With the simplified approach applied in regulation 23, the combination of tanks involved in each damage scenario is not determined and therefore oil retention in non-cargo spaces cannot be directly computed. To account for oil retention in this regulation, the oil outflow from a cargo tank located above a non-cargo space as determined from the hydrostatic balance calculation is multiplied by an outflow reduction factor  $C_{DB(i)}$ .

7.7.4 To determine the outflow factor  $C_{DB(i)}$ , bottom damage outflows for ten actual double tankers as well as the parametric series of designs discussed in paragraph 8 were calculated with and without double bottom retention. The outflow reduction factor fell between 0.50 and 0.70 for all of the actual tankers, and 83% of the designs in the parametric series. On this basis, an outflow reduction factor  $C_{DB(i)}$  of 0.60 was selected. That is,  $(1 - 0.60)$  or 40% of the outflow is assumed to be entrapped by the non-oil tanks below.

## 8 Calculation of the mean outflow parameter

8.1 A collision to grounding ratio of 40%:60% is assumed for the purposes of combining the side and bottom damage outflow values into a single overall mean outflow. This is consistent with the assumption in the Revised Interim Guidelines. The mean outflow parameter  $O_M$  is calculated by dividing the combined side and bottom damage mean outflow by the total cargo volume  $C$ . For the purposes of this regulation as well as the Revised Interim Guidelines, 98% filling is assumed for all oil tanks within the cargo block length.

$$O_M = (0.4 O_{MS} + 0.6 O_{MB}) / C \quad (8.1)$$

## 9 The maximum permissible mean outflow parameter

9.1 A parametric series of 96 designs were evaluated in order to assist in establishing the maximum permissible outflow values. Nine ship sizes were considered, ranging from 5,000 to 460,000 tons deadweight. For each size, a series of designs were evaluated covering variations in cargo tank arrangement, and wing tank and double bottom clearances. Outflow calculations assume the nominal double bottom and wing tank clearances are maintained through the cargo block. When calculating the probabilities of breaching cargo tanks, a simplified prismatic hull shape is assumed.

9.2 The mean outflow parameters are displayed as a function of the cargo capacity in figure 15. In table 1, designs are sorted by mean outflow parameter. The cargo tank arrangement and nominal double hull dimensions are also listed in table 1. For example, “5x2 1x1.1”, refers to a design with cargo tanks arranged two wide and five long; with a 1.0 m wing tank width, and

---

\* Refers to reference (1) on page 43.

a 1.1 m double bottom height. The simplified approach was also evaluated on a series of actual tankers (refer to part A, section 6.4 of these Explanatory Notes for details).

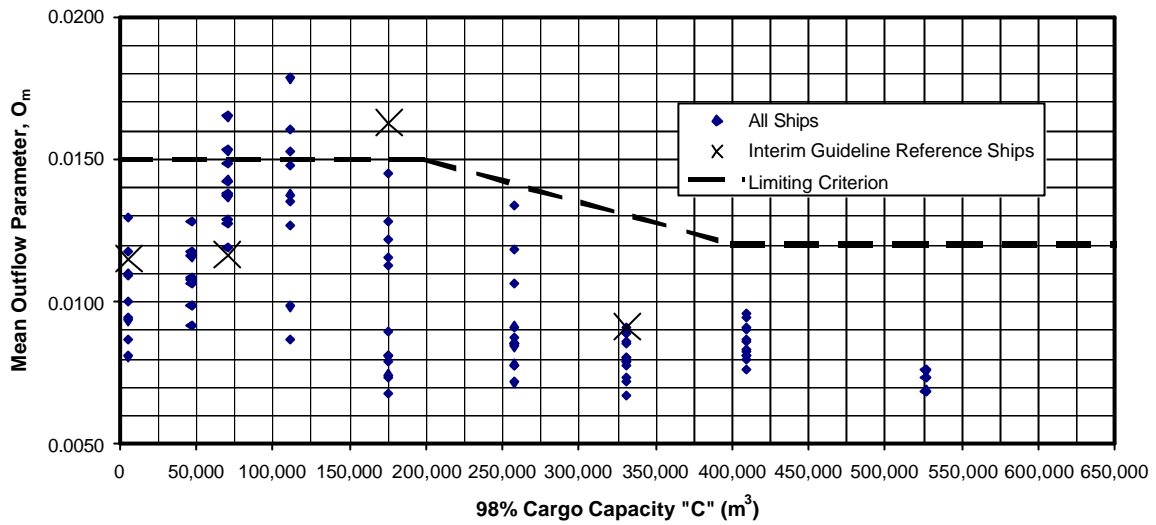


Figure 15 – Graph: Mean Outflow Parameters for Series of Tankers

5,000 MT C=5,849 m <sup>3</sup>	40,000 MT 46,784 m <sup>3</sup>	60,000 MT 70,175 m <sup>3</sup>	95,000 MT 111,111 m <sup>3</sup>	150,000 MT 175,439 m <sup>3</sup>	220,000 MT 257,310 m <sup>3</sup>	283,000 MT 330,994 m <sup>3</sup>	350,000 MT 409,357 m <sup>3</sup>	450,000 MT 526,316 m <sup>3</sup>
Standard 0.015	Standard 0.015	Standard 0.015	5x2 2x2 0.017	5x2 2x2.32 0.018	6x2 2.5x2.5 0.015	Standard 0.013	Standard 0.012	Standard 0.012
5x2 1x1.1 0.013	5x2 2x2 0.013	5x2 2x2 0.014	5x2 2.25x2.25 0.015	6x2 2x2.32 0.016	Standard 0.014	5x5 3x3 0.009	5x4 3x3 0.009	5x4 3x3 0.010
6x2 1x1.1 0.012	5x2 2.25x2.25 0.012	5x2 2.25x2.25 0.013	Standard 0.015	5x2 2.5x2.5 0.015	7x2 2.5x2.5 0.013	5x4 3x3 0.009	5x5 3x3 0.009	5x5 3x3 0.009
5x2 1.25x1.25 0.011	6x2 2x2 0.012	6x2 2x2 0.012	6x2 2x2 0.015	Standard 0.015	6x2 3x3 0.013	5x5 4x2 0.009	5x3 3x3 0.009	5x3 3x3 0.009
7x2 1x1.1 0.011	5x2 2.5x2.5 0.011	5x2 2.5x2.5 0.012	5x2 2.5x2.5 0.014	7x2 2x2.32 0.015	7x2 3x3 0.012	5x3 3x3 0.009	5x5 3.5x3.5 0.009	5x5 3.5x3.5 0.009
6x2 1.25x1.25 0.010	7x2 2x2 0.011	7x2 2x2 0.011	6x2 2.25x2.25 0.014	6x2 2.5x2.5 0.014	6x2 3.5x3.5 0.012	5x5 3.5x3.5 0.009	5x4 3.5x3.5 0.008	5x4 3.5x3.5 0.009
5x2 1.5x1.5 0.009	6x2 2.25x2.25 0.011	6x2 2.25x2.25 0.011	7x2 2x2 0.014	5x2 3x3 0.013	7x2 3.5x3.5 0.011	5x3 4x2 0.009	5x5 4x4 0.008	5x5 4x4 0.008
7x2 1.25x1.25 0.009	7x2 2.25x2.25 0.010	6x2 2.5x2.5 0.011	6x2 2.5x2.5 0.013	7x2 2.5x2.5 0.013	5x3 2.5x2.5 0.009	5x4 4x2 0.008	5x3 3.5x3.5 0.008	6x3 3x3 0.008
6x2 1.5x1.5 0.008	6x2 2.5x2.5 0.010	7x2 2.25x2.25 0.011	7x2 2.25x2.25 0.013	6x2 3x3 0.012	6x3 2.5x2.5 0.008	5x4 3.5x3.5 0.008	6x3 3x3 0.008	5x3 3.5x3.5 0.008
7x2 1.5x1.5 0.008	7x2 2.5x2.5 0.009	7x2 2.5x2.5 0.010	7x2 2.5x2.5 0.012	7x2 3x3 0.011	5x3 3x3 0.008	5x3 3.5x3.5 0.008	5x4 4x4 0.008	5x4 4x4 0.008
				5x3 2x2.32 0.010	5x3 3.5x3.5 0.007	6x3 3x3 0.008	5x3 4x4 0.007	5x3 4x4 0.008
				5x3 2.5x2.5 0.009	6x3 3x3 0.007	6x3 4x2 0.008	6x3 3.5x3.5 0.007	6x3 3.5x3.5 0.007
				5x3 3x3 0.008	6x3 3.5x3.5 0.007	6x3 3.5x3.5 0.007	6x3 4x4 0.007	6x3 4x4 0.007

Table 1 – Mean Outflow Parameters for Series of Tankers

9.3 Figure 16 shows the maximum permissible mean outflow parameter for oil tankers and combination carriers of 5,000 metric tons deadweight and above. The criterion for combination carriers may be applied if calculations demonstrate that the increased structural strength of the combination carrier provides outflow equivalency at least equal to a standard double hull tanker of equal size.

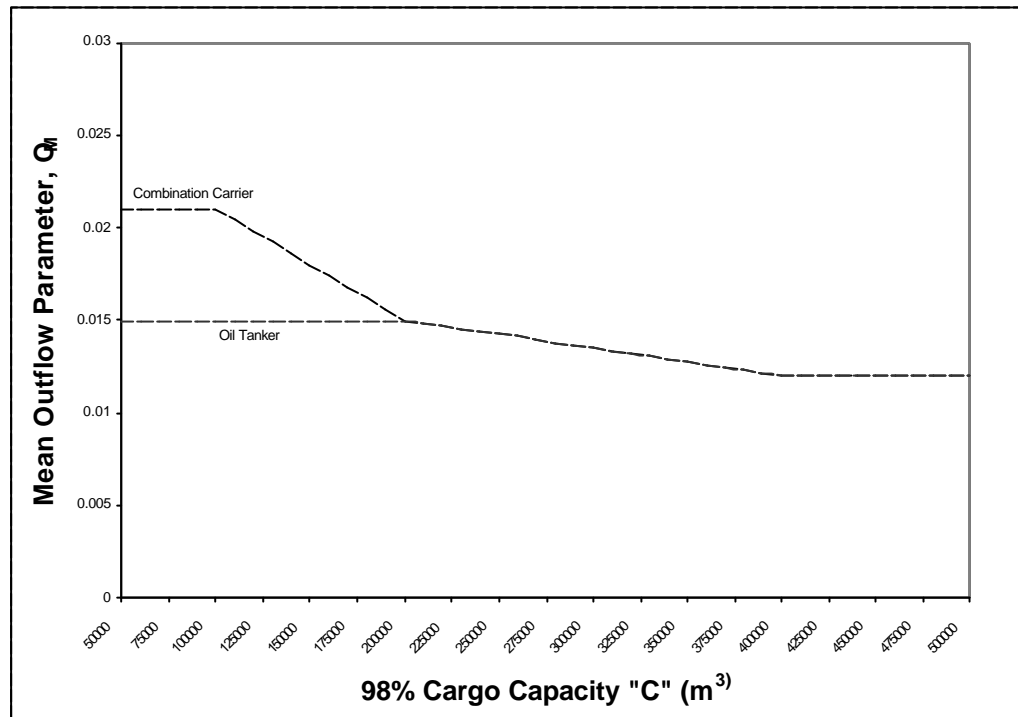


Figure 16 – Graph: Mean Outflow Parameter Criterion as per regulation 23, paragraph 3.1



## PART B - GUIDANCE ON INDIVIDUAL REGULATIONS

**1 This part of these explanatory notes provides guidance on application of certain of the provisions of regulation 23.**

### **2 Regulation 23.3.1**

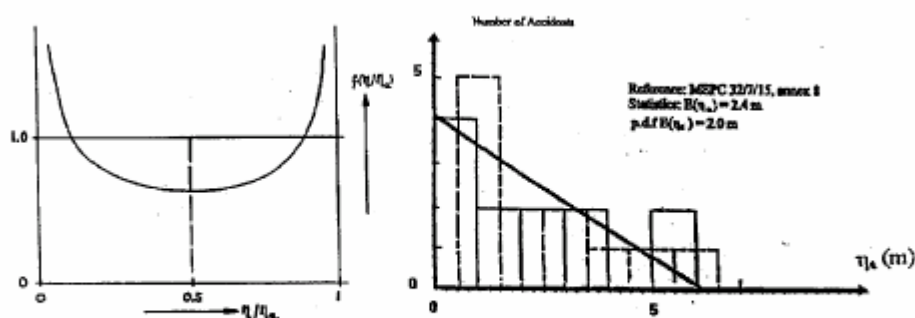
2.1 For combination carriers, a separate criterion for the mean oil outflow parameter may be applied provided it is demonstrated by calculations that the increased structural strength of the design is providing for environmental protection at least equivalent to a standard double hull oil tanker of the same size. The calculations are to be to the satisfaction of the Administration.

2.2 These standard oil tankers shall comply with MARPOL 73/78, including the requirements relating to width of wing-tanks and height of double bottom. The scantlings of the standard tanker shall be as per the requirements for a tanker of the same size as the combination carrier, and with the same loading conditions, apart from the dry bulk conditions.

2.3 The calculations are to demonstrate the enhanced strength of the double bottom and/or side structure of the combination carrier sufficiently reduces the extent of damage, such that the oil outflow performance of the combination carrier is comparable to that of the standard oil tanker referred to above in terms of the extent of damage and influence on oil outflow. The calculations are to include a series of collision and/or grounding calculations by means of finite element method (FEM) or other appropriate means. For each damage position (each collision or grounding case) a development of dissipated plastic deformation energy shall be evaluated. The collision calculations shall be carried out assuming the combination carrier being the struck ship at full load condition for different striking positions defined by the draught differences to the striking ship.

### **3 Regulation 23.3.2**

3.1 The probabilistic methodology for hypothetical oil outflow applies to tankers of 5,000 DWT and above only, and does not have an outflow criterion for the smaller vessels. In this case, tank size is governed by the 700 m<sup>3</sup> tank size limitation required by paragraph 6.2 of regulation 19 of the revised MARPOL Annex I and the maximum tank length specified in paragraph 3.2.



#### 4 Regulations 23.4.3 and 23.4.4

4.1 In accordance with paragraph 4.4, cargo density is determined by dividing the total deadweight at the summer load line draft by the total cargo volume. It is recognized that loading the vessel with maximum cargo and no consumables may result in trim of the vessel. However, for the purposes of this regulation calculations should be carried out based on a hypothetical condition with zero trim and zero heel. The use of a hypothetical condition rather than actual load cases was adopted in order to insure uniform application of this regulation.

#### 5 Regulation 23.4.5

5.1 The permeability of cargo tanks should be taken as 0.99. This is less than the value of 0.95 typically applied for tanks when assessing damage stability, but is considered a more realistic permeability for cargo tanks of double hull tankers that are relatively free of structure.

#### 6 Regulation 23.5.1

6.1 For an oil tanker that is symmetrical about the ship's centreline, the mean oil outflow values  $O_{MS}$  and  $O_{MB}$  are calculated assuming damage to one side of the ship only. For designs with asymmetrical cargo tank arrangements, calculations should be performed from both sides and the results averaged.

6.2 For side damage, the probabilities of damage are derived from five dimensions as defined in paragraph 8.2. These are:  $X_a$ ,  $X_f$ ,  $Z_t$ ,  $Z_u$ , and  $y$ .  $X_a$ ,  $X_f$ ,  $Z_t$ , and  $Z_u$  will have the same values, for both port and starboard damage. For damage from the starboard side,  $y$  is measured inboard from the starboard side shell. For damage from the port side,  $y$  is measured inboard from the port side shell. This will result in two outflow values for side damage,  $O_{MS-port}$  and  $O_{MS-starboard}$ . Averaging these values yields the overall mean outflow from side damage.

$$O_{MS} = (O_{MS-port} + O_{MS-starboard}) / 2 \quad (6.2)$$

6.3 As described in paragraph 9.2, for bottom damage the probabilities are derived from the following dimensions:  $X_a$ ,  $X_f$ ,  $Y_p$ ,  $Y_s$ , and  $z$ . The methodology is based on the centre of damage located to the starboard side. Therefore, the values  $Y_p$  and  $Y_s$  represent the distances from the compartment boundaries to the starboard side of the shell, represented by a vertical plane located  $B_B/2$  to starboard of the ship's centreline. In the case of an asymmetrical arrangement, a second set of calculations are done assuming the distances  $Y_p$  and  $Y_s$  are measured to a plane located  $B_B/2$  to port of the ship's centreline.  $X_a$ ,  $X_f$ , and  $z$  will have the same values, for both port and starboard damage. Similar to side damage, the values for port and starboard damage are averaged to obtain the overall mean outflow from bottom damage:

$$O_{MB} = (O_{MB-port} + O_{MB-starboard}) / 2 \quad (6.3)$$

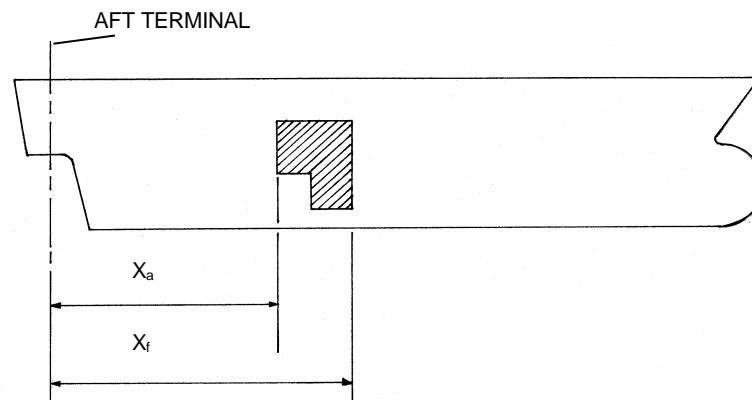
## 7 Regulation 23.7.3.2

7.1 It is recognized that in actual damage scenarios, where the cargo density exceeds the seawater density, all or most of the cargo may be lost in the event of bottom damage. However, for the purposes of these calculations, even in cases where the nominal cargo oil density as calculated in paragraph 4.4 exceeds the density of seawater, the cargo level and remaining oil after damage should still be calculated based on hydrostatic pressure balance in accordance with paragraph 7.3.2.

## 8 Regulation 23.8.2

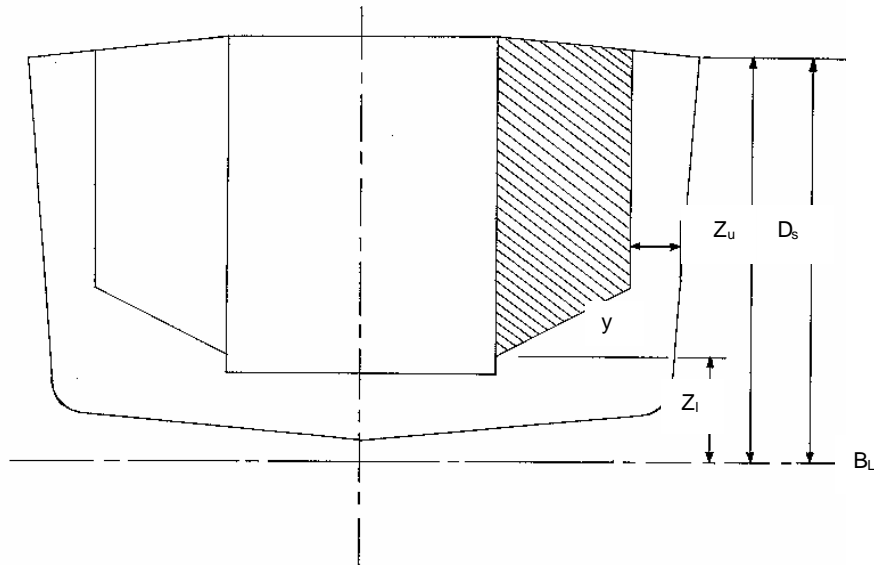
8.1 Compartment boundaries  $X_a$ ,  $X_f$ ,  $Z_l$ ,  $Z_u$  and  $y$  shall be developed as shown in the figures below. The shaded region represents the cargo tank under consideration.

- $X_a$  = the longitudinal distance from the aft terminal of L to the aft most point on the compartment being considered;
- $X_f$  = the longitudinal distance from the aft terminal of L to the foremost point on the compartment being considered;

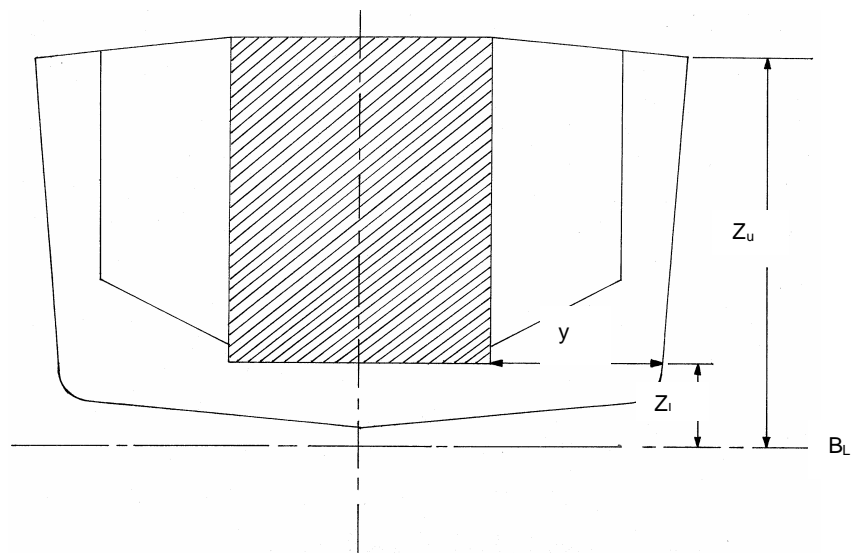


**Figure 17- Definition of  $X_a$  and  $X_f$   
(Profile-looking inboard)**

- $Z_l$  = the vertical distance from the moulded baseline to the lowest point on the compartment being considered;
- $Z_u$  = the vertical distance from the moulded baseline to the highest point on the compartment being considered.  $Z_u$  is not to be taken greater than  $D_s$ ; and
- $y$  = the minimum horizontal distance measured at right angles to the centreline between the compartment under consideration and the side.

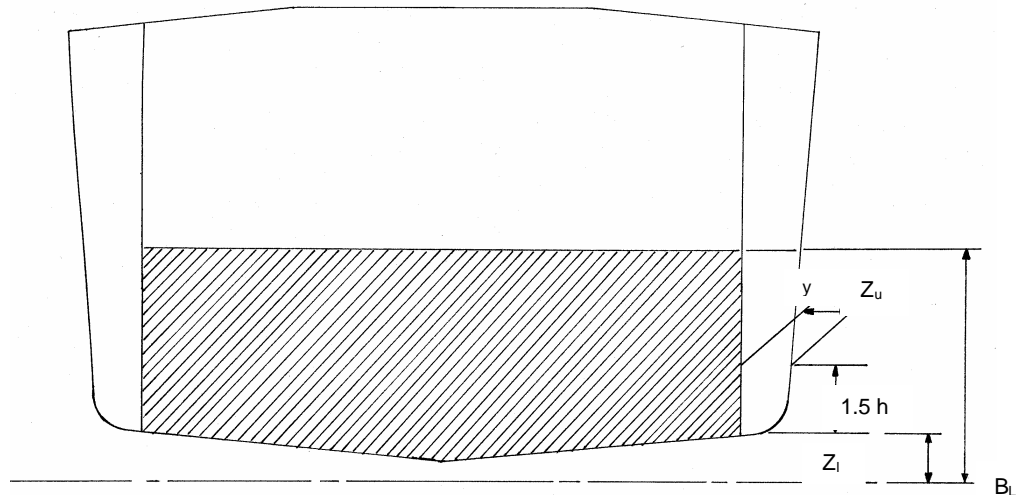


**Figure 18 –  $Z_u$ ,  $Z_i$  and  $y$  for outer cargo tank  
(Section looking forward)**



**Figure 19 –  $Z_u$ ,  $Z_i$  and  $y$  for centre cargo tank  
(Section looking forward)**

An example showing how to measure  $y$ , in particular for a mid-deck tanker, is shown below.  $y$  shall be measured at the position above  $1.5h$ , where  $h$  is defined as per paragraph 2.2 of regulation 19 of the revised MARPOL Annex I.

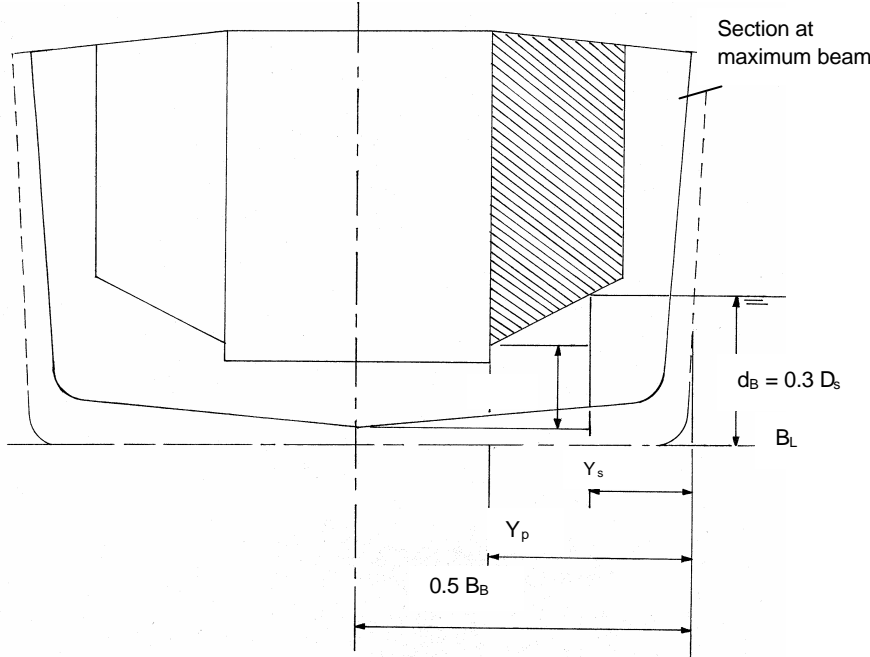


**Figure 20 –  $Z_u$ ,  $Z_l$  and  $y$  for mid-deck tanker  
(Section looking forward)**

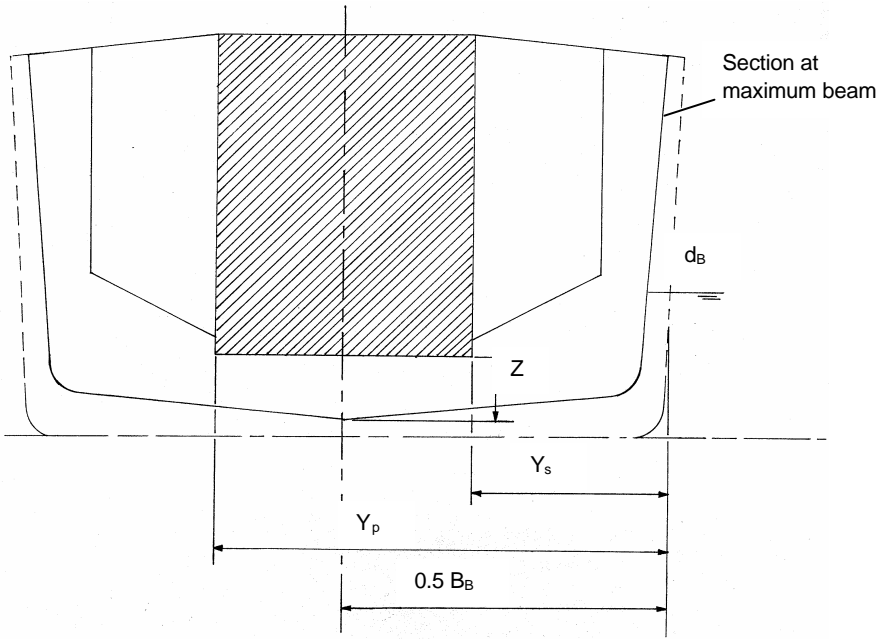
**9 Regulation 23.9**

9.1 Compartment boundaries  $Y_p$ ,  $Y_s$ , and  $z$  shall be developed as shown in the figures below:

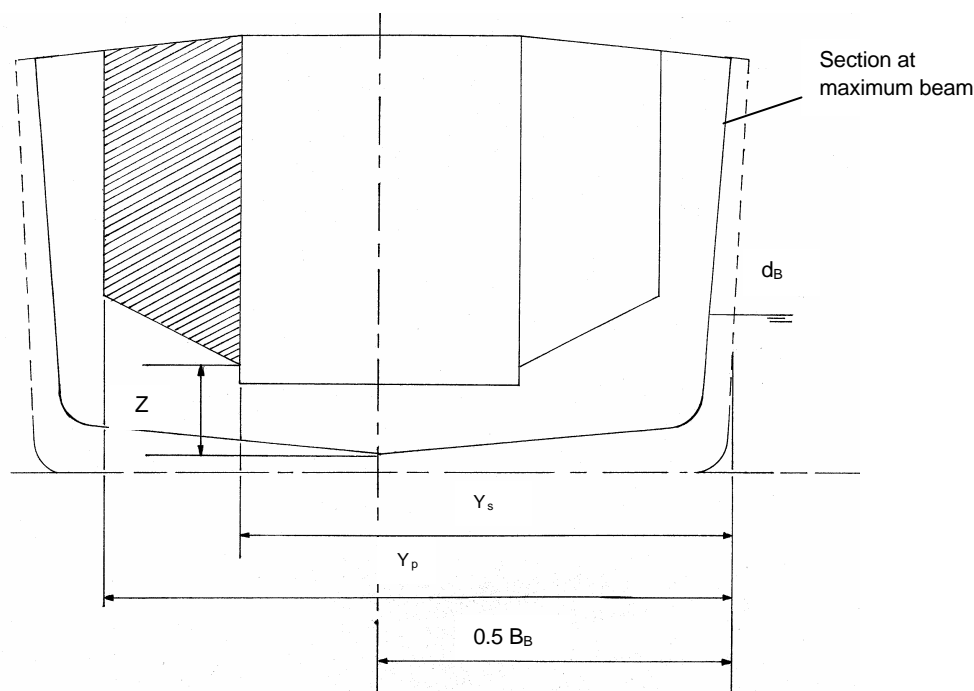
- $Y_p$  = the transverse distance from the port-most point on the compartment located at or below the waterline  $d_B$ , to a vertical plane located  $B_B / 2$  to starboard of the ship's centreline;
- $Y_s$  = the transverse distance from the starboard-most point on the compartment located at or below the waterline  $d_B$ , to a vertical plane located  $B_B / 2$  to starboard of the ship's centreline; and
- $z$  = the minimum value of  $z$  over the length of the compartment, where, at any given longitudinal location,  $z$  is the vertical distance from the lower point of the bottom shell at that longitudinal location to the lower point of the compartment at that longitudinal location.



**Figure 21 –  $Y_s$ ,  $Y_p$  and  $z$  for starboard cargo tank  
(Section looking forward)**



**Figure 22 –  $Y_s$ ,  $Y_p$  and  $z$  for centre cargo tank  
(Section looking forward)**



**Figure 23 –  $Y_s$ ,  $Y_p$  and  $z$  for port cargo tank**  
(Section looking forward)

[ $Y_p$  should be corrected to the intersection of  $d_B$  and the port most cargo tank boundary]

## 10 Regulation 23.10.1

### 10.1 Introduction

10.1.1 The mean oil outflow parameter ( $O_M$ ) may be calculated either damage scenario method or damaged tank method. The damage scenario method is denoted in the Revised Interim Guidelines referred to in the revised MARPOL Annex I regulation 19.5 and the simplified approach of damaged tank method is described in regulation 23.

10.1.2 The damaged tank method as applied in the revised MARPOL Annex I regulation 23 is much simpler, and gives the same calculation results as those by the damage scenario method for the ships having rectangular hull form and tanks. For the actual ships having hull curvature and sloped shape tanks, however, the calculation results by the simplified method are higher than the correct values.

10.1.3 Considering the above gap by the simplified damaged tank method, regulation 23.10 states that more rigorous calculations may be appropriate. The damaged tank method through application of hypothetical sub-compartments, as well as the damage scenario method denoted in the Revised Interim Guidelines referred to in the revised MARPOL Annex I regulation 19.5 are designated as rigorous calculation procedures in the revised MARPOL Annex I regulations 23.10.1 to 23.10.3.

## 10.2 Hypothetical sub-compartment Calculation Procedure:

10.2.1 The probability  $P_S$  and  $P_B$  of each cargo tank in regulation 23.8 and 23.9 can be calculated through application of hypothetical sub-compartments using the following equations :

$$P_S = \sum_J^{2n_{sx}-1} \sum_K^{2n_{sz}-1} (P_{sx(J+1)} - P_{sx(J)})(P_{sz(K+1)} - P_{sz(K)})(1 - P_{sy(J, K)}) \quad (10.2.1-1)$$

where:

- $n_{sx}$  = total number of longitudinal sub-compartments
- $n_{sz}$  = total number of vertical sub-compartments
- $j$  = 1 ~  $n_{sx}$ , represents each longitudinal sub-compartment
- $k$  = 1 ~  $n_{sz}$ , represents each vertical sub-compartment
- $P_{sx(j)}$  = probability of damage for longitudinal sub-compartment, in small order of  $1 - P_{sf(j)}$  and  $P_{sa(j)}$ ,  $j = 1 \sim n_{sx}$
- $P_{sz(k)}$  = probability of damage for vertical sub-compartment, in small order of  $1 - P_{su(k)}$  and  $P_{sl(k)}$ ,  $k = 1 \sim n_{sz}$
- $J$  = 1 ~  $2n_{sx}$
- $K$  = 1 ~  $2n_{sz}$
- $P_{sY(J, K)}$  = probability of damage by the smallest  $y_{jk}$  of sub-compartments of which the probability range between  $1 - P_{sf(j)}$  and  $P_{sa(j)}$  or between  $1 - P_{su(k)}$  and  $P_{sl(k)}$  includes the range between  $P_{sx(J+1)}$  and  $P_{sx(J)}$  or between  $P_{sz(K+1)}$  and  $P_{sz(K)}$

$P_{sf(j)}$ ,  $P_{sa(j)}$ ,  $P_{su(k)}$ ,  $P_{sl(k)}$  and  $y_{jk}$  shall be calculated by the definition of regulation 23.8 for sub-compartments

$$P_B = \sum_L^{2n_{Bx}-1} \sum_M^{2n_{By}-1} (P_{Bx(L+1)} - P_{Bx(L)})(P_{By(M+1)} - P_{By(M)})(1 - P_{Bz(L, M)}) \quad (10.2.1-2)$$

where:

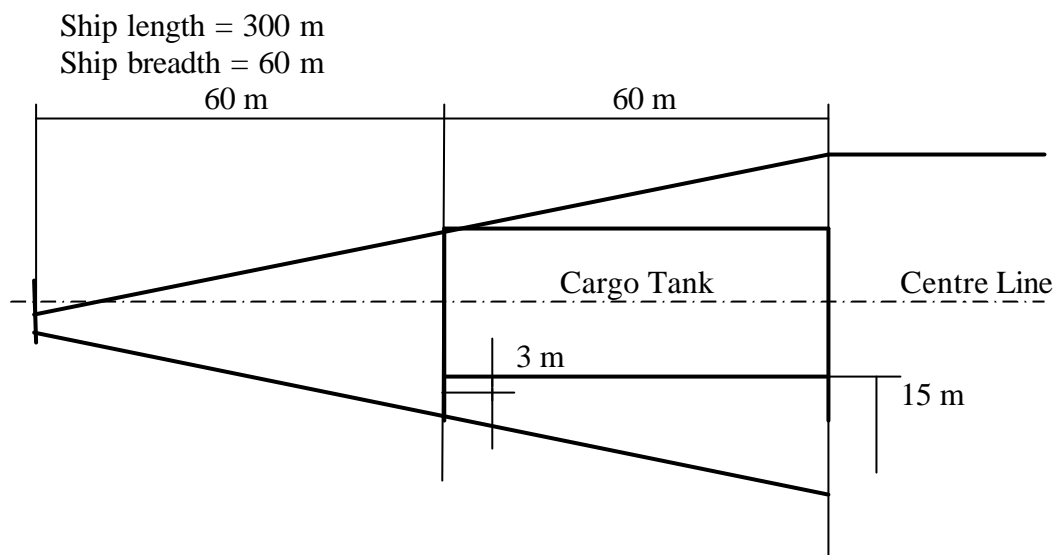
- $n_{Bx}$  = total number of longitudinal sub-compartments
- $n_{By}$  = total number of transverse sub-compartments
- $l$  = 1 ~  $n_{Bx}$ , represents each longitudinal sub-compartment
- $m$  = 1 ~  $n_{By}$ , represents each transverse sub-compartment
- $P_{Bx(L)}$  = probability of damage for longitudinal sub-compartment, in small order of  $1 - P_{Bf(l)}$  and  $P_{Ba(l)}$ ,  $l = 1 \sim n_{Bx}$
- $P_{By(M)}$  = probability of damage for transverse sub-compartment, in small order of  $1 - P_{Bp(m)}$  and  $P_{Bs(m)}$ ,  $m = 1 \sim n_{By}$
- $L$  = 1 ~  $2n_{Bx}$
- $M$  = 1 ~  $2n_{By}$
- $P_{Bz(L, M)}$  = probability of damage by the smallest  $z_{lm}$  of sub-compartments of which the probability range between  $1 - P_{Bf(l)}$  and  $P_{Ba(l)}$  or between  $1 - P_{Bp(m)}$  and  $P_{Bs(m)}$  includes the range between  $P_{Bx(L+1)}$  and  $P_{Bx(L)}$  or between  $P_{By(M+1)}$  and  $P_{By(M)}$

$P_{Bf(l)}$ ,  $P_{Ba(l)}$ ,  $P_{Bs(m)}$ ,  $P_{Bp(m)}$  and  $z_{lm}$  shall be calculated by the definition of regulation 23.9 for sub-compartments



### 10.3 Example of the hypothetical sub-compartment calculation

10.3.1 Sample calculations by the above procedure are carried out for the side damage and the probabilities  $P_s$  are compared with those by the damage scenario method denoted in the Revised Interim Guidelines referred to in the revised MARPOL Annex I regulation 19.5. To simplify the evaluation, the following simple 2-dimensional tank and hull model are assumed.



**Figure 24 – Arrangements for hypothetical sub-compartment calculation example**

In the case that no sub-compartment is assumed, the probability  $P_s$  is calculated according to the revised MARPOL Annex I regulation 23.8 as follows:

$X_a$ (m)	$X_f$ (m)	$X_a/L$	$X_f/L$	$P_{S_a}$	$P_{S_f}$	$1-P_{S_f}$	$1-P_{S_f}-P_{S_a}$
60	120	0.20	0.40	0.167	0.567	0.433	0.266

$y$ (m)	$P_{S_y}$	$1-P_{S_y}$
3	0.749	0.251

$P_s=(1-P_{S_f}-P_{S_a})(1-P_{S_y})$
0.066766

Calculations by the formula in paragraph 10.2 are carried out for several numbers of sub-compartments. For example, the probability  $P_s$  assuming four (4) sub-compartments is shown below:

$j$	$X_a$ (m)	$X_f$ (m)	$X_a/L$	$X_f/L$	$P_{S_a}$	$P_{S_f}$	$1-P_{S_f}$
1	60	75	0.20	0.25	0.167	0.717	0.283
2	75	90	0.25	0.30	0.217	0.667	0.333
3	90	105	0.30	0.35	0.267	0.617	0.383
4	105	120	0.35	0.40	0.317	0.567	0.433

The  $Ps_a$  and  $1-Ps_f$  values are sorted in ascending order, as shown below:

J.	$Ps_a$	$1-Ps_f$
	Values sorted ascending	
1	<b>0,167</b>	
2	<b>0,217</b>	
3	<b>0,267</b>	
4		<b>0,283</b>
5	<b>0,317</b>	
6		<b>0,333</b>
7		<b>0,383</b>
8		<b>0,433</b>

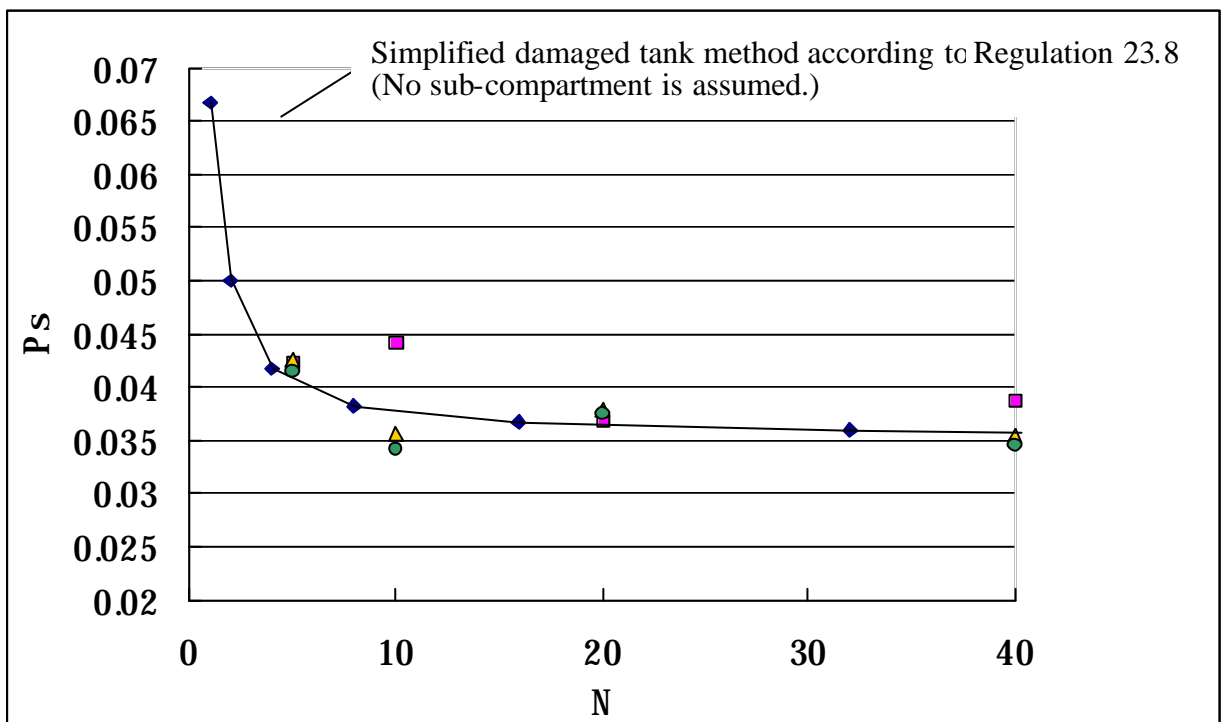
$Ps_x (J)$	$Ps_x (J+1)$
<b>0,167</b>	
<b>0,217</b>	<b>0,217</b>
<b>0,267</b>	<b>0,267</b>
<b>0,283</b>	<b>0,283</b>
<b>0,317</b>	<b>0,317</b>
<b>0,333</b>	<b>0,333</b>
<b>0,383</b>	<b>0,383</b>
	<b>0,433</b>

In the table below, each hypothetical sub-compartment or group of hypothetical sub-compartments (j) is associated with the minimum distance (y) to the outer shell. Each probability of breaching a hypothetical sub-compartment or exact group of hypothetical sub-compartments (j) is then evaluated by multiplying the longitudinal and transverse probabilities:

J	$Ps_x (J)$	$Ps_x (J+1)$	$Ps_x (J+1) - Ps_x (J)$	jj	y (m)	$Ps_y (J)$	$1 - Ps_y (J)$	$(Ps_x (J+1) - Ps_x (J)) \times (1 - Ps_y (J))$
1	0.167	0.217	0.050	1	3	0.749	0.251	0.012550
2	0.217	0.267	0.050	1,2	3	0.749	0.251	0.012550
3	0.267	0.283	0.016	1,2,3	3	0.749	0.251	0.004016
4	0.283	0.317	0.034	2,3	6	0.888	0.112	0.003808
5	0.317	0.333	0.016	2,3,4	6	0.888	0.112	0.001792
6	0.333	0.383	0.050	3,4	9	0.916	0.084	0.004200
7	0.383	0.433	0.050	4	12	0.944	0.056	0.002800
							S	0.041716

10.3.2 The results of the calculation together with those by the damage scenario method denoted in the Revised Interim Guidelines referred to in the revised MARPOL Annex I regulation 19.5 are shown in the following graph. It is demonstrated that the calculation procedure through application of hypothetical sub-compartments gives the damage probability gradually approaching to the correct value as the number of sub-compartments is increased:

Calculation method	Definition of N	Symbol	Other calculation conditions
Damaged tank method through application of hypothetical sub-compartments	The number of longitudinal sub-compartments	?	-
Damage scenario method denoted in the Revised Interim Guidelines referred to in regulation 19.5	The number of steps for longitudinal location	i	Longitudinal extent at 3 steps Transverse extent at 6 steps
		?	Longitudinal extent at 6 steps Transverse extent at 6 steps
		?	Longitudinal extent at 6 steps Transverse extent at 12 steps



## PART C – EXAMPLES

### 1 Tank barge example

#### 1.1 General

1.1.1 The application of the Accidental Oil Outflow Performance regulation is shown in the following worked example illustrating the calculation procedure for a tank barge.

1.1.2 The arrangement and dimensions of the sample barge are as shown figure 26. For clarity purposes, a simple arrangement has been selected which does not comply with all MARPOL requirements. However, for actual designs, the vessel must satisfy all applicable regulations of MARPOL Annex I.

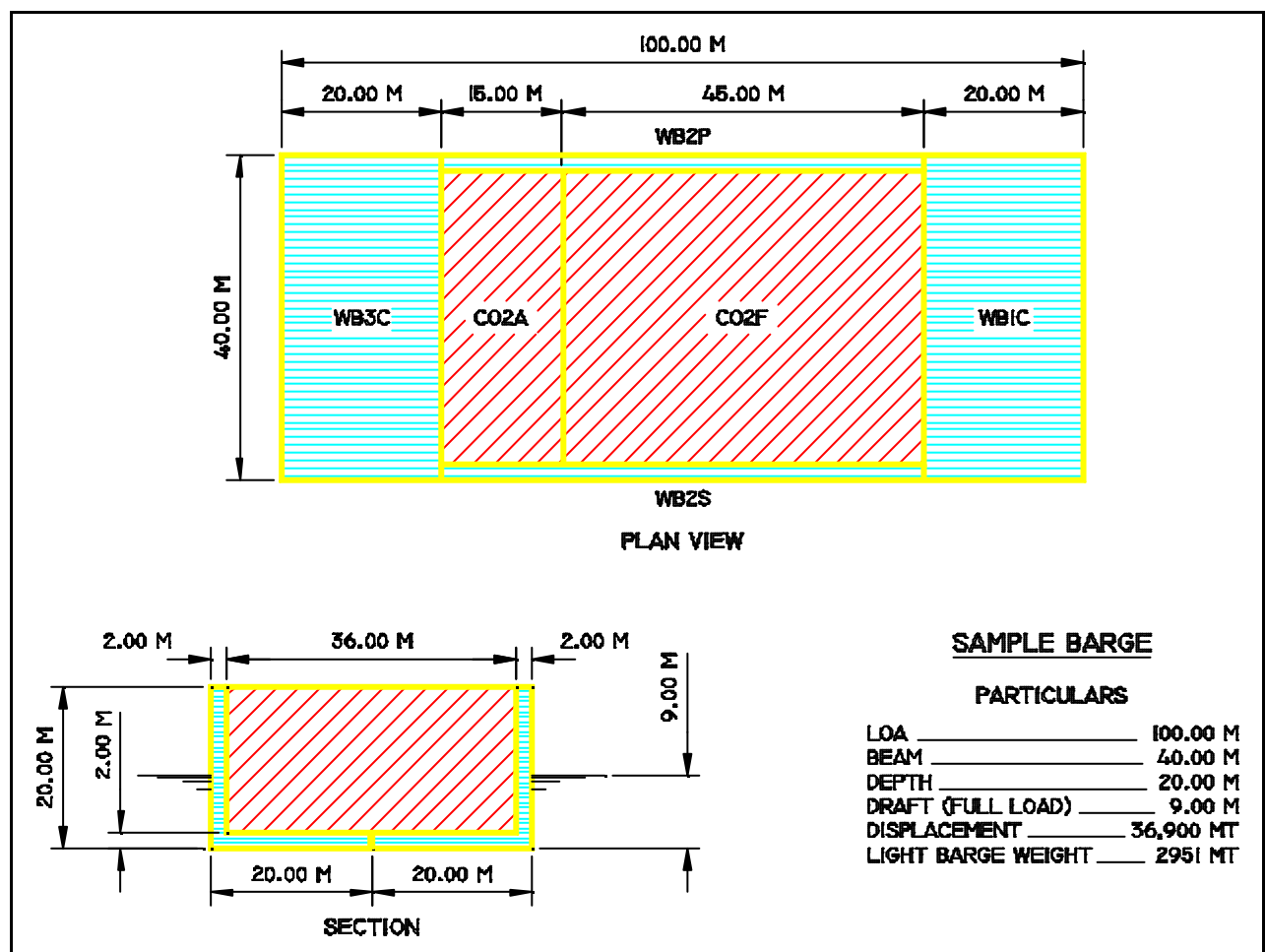


Figure 26 – Barge Arrangement

#### 1.2 Establishing the nominal cargo oil density

1.2.1 The deadweight (DW) equals the displacement at the summer load line draft measured in seawater with a density of 1.025 t/m<sup>3</sup> minus the lightship. No deduction is taken for consumables.

$$DW = 36,900 - 2,951 = 33,949 \text{ t}$$

1.2.2 The cargo volume C equals the total cargo volume at 98% filling. In accordance with paragraph 4.5 of regulation 23, the capacity of cargo tanks are calculated based on a permeability of 0.99.

	100% Capacity (m <sup>3</sup> )	98% Filling (m <sup>3</sup> )
CO1	9,623	9,430
CO2	28,868	28,291
C=		37,721

1.2.3 In accordance with paragraph 4.4 of regulation 23, the nominal density is calculated as follows:

$$\rho_n = 1000 (DW)/C \text{ (kg/m}^3\text{)} = 1000 (33,949)/37,721 = 900 \text{ kg/m}^3 \quad (1.2.3)$$

### 1.3 Calculating the probabilities of side damage

1.3.1 The first step is to determine the values for the dimensions and clearances  $X_a$ ,  $X_f$ ,  $Z_l$ ,  $Z_u$  and  $y$  as defined in paragraph 8.2 of regulation 23:

Tank	$X_a$ m-AP	$X_f$ m-AP	$Z_l$ m-BL	$Z_u$ m-BL	$y$ m
CO1	20.000	35.000	2.000	20.000	2.000
CO2	35.000	80.000	2.000	20.000	2.000

1.3.2 From the ratios  $X_a/L$ ,  $X_f/L$ ,  $Z/B_s$ ,  $Z_l/D_s$ ,  $Z_u/D_s$ ,  $Y_l/D_s$ , and  $y$ , the probabilities associated with these subdivision locations are interpolated from the table of probabilities for side damage provided in Paragraph 8.3 of regulation 23. For instance, for compartment CO1, the forward boundary  $X_f$  is at 35.0 m from the A.P, and  $X_f/L = 0.35$ . From the table, we find that  $P_{sf} = 0.617$ . The probabilities for CO1 and CO2 are as follows:

Tank	$X_a/L$	$P_{sa}$	$X_f/L$	$P_{sf}$	$Z_l/D_s$	$P_{sl}$	$Z_u/D_s$	$P_{su}$	$y/B_s$	$P_{sy}$
CO1	0.2000	0.1670	0.3500	0.6170	0.1000	0.0010	1.0000	0.0000	0.0500	0.7490
CO2	0.3500	0.3170	0.8000	0.1670	0.1000	0.0010	1.0000	0.0000	0.0500	0.7490

1.3.3 In accordance with paragraph 8 of regulation 23, the probability factors are then combined to find the probability,  $P_s$ , of breaching a compartment from side damage.

For tank CO1:

$$P_{SL} = (1 - P_{sf} - P_{sa}) = (1 - 0.617 - 0.167) = 0.216$$

$$P_{SV} = (1 - P_{su} - P_{sl}) = (1 - 0.000 - 0.001) = 0.999$$

$$P_{ST} = (1 - P_{sy}) = (1 - 0.749) = 0.251$$

$$P_s = P_{SL} P_{SV} P_{ST} = (0.216)(0.999)(0.251) = 0.0542$$

For tank CO2:

$$P_{SL} = (1 - P_{sf} - P_{sa}) = (1 - 0.167 - 0.317) = 0.516$$

$$P_{SV} = (1 - P_{su} - P_{sl}) = (1 - 0.000 - 0.001) = 0.999$$

$$P_{ST} = (1 - P_{sy}) = (1 - 0.749) = 0.251$$

$$P_s = P_{SL} P_{SV} P_{ST} = (0.516)(0.999)(0.251) = 0.1294$$

1.3.4 Given a collision that penetrates the outer hull,  $P_s$  is the probability that the damage will extend into a particular cargo tank. As shown above, the probability of breaching the CO2 tank from side damage is 0.1294, or about 12.9%.

#### 1.4 Calculating the mean outflow from side damage

1.4.1 For side damage, the total content of the tank is assumed to outflow into the sea when the tank is penetrated. Thus, the mean outflow is calculated by summing the products of the cargo tank volumes at 98% filling and the associated probabilities, in accordance with the formula given in paragraph 6 of regulation 23:

$$O_{MS} = \sum_i^n C_3 P_{s(i)} O_{s(i)} \quad (\text{m}^3) \quad (1.4.1)$$

1.4.2  $C_3 = 0.77$  for ships having two longitudinal bulkheads inside the cargo tanks extending over the length of the cargo block, and 1.0 for all other ships. In this case, there are no longitudinal bulkheads within the cargo tanks, and  $C_3 = 1.0$ .

The mean oil outflow from side damage is therefore:

$$O_{MS} = (1.0)(0.0542)(9,430) + (1.0)(0.1294)(28,291) = 4,172 \text{ m}^3$$

#### 1.5 Calculating the probabilities of bottom damage

1.5.1 The first step is to determine the values for the dimensions and clearances  $X_a$ ,  $X_f$ ,  $Y_p$ ,  $Y_s$  and  $z$ .  $X_a$  and  $X_f$  are as previously specified for side damage.  $Y_p$ ,  $Y_s$  and  $z$  are defined in paragraph 9.2 of regulation 23:

Tank	$Y_p$ m	$Y_s$ m	$z$ m
CO1	38.000	2.000	2.000
CO2	38.000	2.000	2.000

1.5.2 From the ratios  $X_a/L$ ,  $X_f/L$ ,  $Y_p/B_B$ ,  $Y_s/B_B$ , and  $z$ , the probabilities associated with these subdivision locations are interpolated from the table of probabilities for bottom damage provided in Paragraph 9.3 of regulation 23.

Tank	$X_a/L$	$P_{Ba}$	$X_f/L$	$P_{Bf}$	$Y_p/B_B$	$P_{Bp}$	$Y_s/B_B$	$P_{Bs}$	$z/D_s$	$P_{Bz}$
CO1	0.2000	0.0290	0.3500	0.8100	0.9500	0.0090	0.0500	0.0090	0.1000	0.7800
CO2	0.3500	0.0760	0.8000	0.2520	0.9500	0.0090	0.0500	0.0090	0.1000	0.7800

1.5.3 In accordance with paragraph 8 of regulation 23, the probability factors are then combined to find the probability,  $P_B$ , of breaching a compartment from bottom damage.

For tank CO1:

$$P_{BL} = (1 - P_{Bf} - P_{Ba}) = (1 - 0.810 - 0.029) = 0.161$$

$$P_{BT} = (1 - P_{Bp} - P_{Bs}) = (1 - 0.009 - 0.009) = 0.982$$

$$P_{BV} = (1 - P_{Bz}) = (1 - 0.780) = 0.220$$

$$P_B = P_{BL} P_{BT} P_{BV} = (0.161)(0.982)(0.220) = 0.0348$$

For tank CO2:

$$P_{BL} = (1 - P_{BF} - P_{Ba}) = (1 - 0.252 - 0.076) = 0.672$$

$$P_{BT} = (1 - P_{Bp} - P_{Bs}) = (1 - 0.009 - 0.009) = 0.982$$

$$P_{BV} = (1 - P_{Bz}) = (1 - 0.780) = 0.220$$

$$P_B = P_{BL} P_{BT} P_{BV} = (0.161)(0.982)(0.220) = 0.1452$$

1.5.4 Given a grounding that penetrates the outer hull,  $P_B$  is the probability that the damage will extend into a particular cargo tank. As shown above, the probability of breaching the CO2 tank from bottom damage is 0.1452, or about 14.5%.

## 1.6 Calculating the mean outflow from bottom damage

1.6.1 For bottom damage, outflow is computed based on hydrostatic pressure balance, in accordance with the assumptions described in paragraph 7 of regulation 23. Independent calculations are performed for 0.0 m and minus 2.5 m tides, and then the results are combined to provide an overall mean outflow for bottom damage.

1.6.2 Per paragraph 7.3.2 of regulation 23, the cargo level after damage, measured in metres above  $Z_l$ , is calculated as follows:

$$h_c = \{ (d_s + t_c - Z_l) (\rho_s) - (1000 p) / g \} / \rho_n$$

where:

$d_s$  = the load line draught = 9.0 m

$t_c$  = the tidal change = 0 m and -2.5 m

$Z_l$  = the height of the lowest point in the cargo tank above baseline = 2.0 m

$\rho_s$  = density of seawater, to be taken as 1,025 kg/m<sup>3</sup>

$p$  = inert gas overpressure = 5 kPa

$g$  = acceleration of gravity = 9.81 m/s<sup>2</sup>

$\rho_n$  = nominal density of cargo oil = 900 kg/m<sup>3</sup>

For 0.0 m tide:

$$h_c = \{ (9.0 + 0.0 - 2.0)(1,025) - (1000)(5) \} / 900 = 7.406 \text{ m}$$

For 2.5 m tide:

$$h_c = \{ (9.0 - 2.5 - 2.0)(1,025) - (1000)(5) \} / 900 = 4.559 \text{ m}$$

1.6.3 The oil outflow,  $O_B$ , from each tank due to bottom damage equals the original volume (98% of tank capacity) minus the amount remaining (oil up to level  $h_c$ ).

Tank	Oil Outflow (m <sup>3</sup> ) at	
	at 0.0 m time	at -2.5 m tide
CO1	5,471	6,993
CO2	16,413	20,979

1.6.4 In accordance with paragraphs 7.1 and 7.2 of regulation 23, the mean outflow from bottom damage is calculated as follows:

$$O_{MB(0)} = \sum_i^n P_{B(i)} O_{B(i)} C_{DB(i)} \quad (\text{m}^3)$$

$$O_{MB(2.5)} = \sum_i^n P_{B(i)} O_{B(i)} C_{DB(i)} \quad (\text{m}^3)$$

1.6.5 It is recognized that a portion of the oil escaping from a cargo tank may be entrapped by a double bottom tank below, thereby preventing the oil from reaching the sea. In accordance with paragraph 7.4 of regulation 23,  $C_{DB(i)}$  is to be taken as 0.6 when a cargo tank is bounded from below by a non-oil compartment.

1.6.6 The mean outflow from bottom damage without tidal change is:

Tank	$P_{B(i)}$	$O_{B(i)}$ (m <sup>3</sup> )	$C_{DB(i)}$	$O_{MB(i)}$ (m <sup>3</sup> )
CO1	0.0348	5,471	0.6	114
CO2	0.1452	16,413	0.6	1,430
			$O_{MB(0)} =$	1,544

1.6.7 The mean outflow after a 2.5 m reduction in tide is:

Tank	$P_{B(i)}$	$O_{B(i)}$ (m <sup>3</sup> )	$C_{DB(i)}$	$O_{MB(i)}$ (m <sup>3</sup> )
CO1	0.0348	6,993	0.6	146
CO2	0.1452	20,979	0.6	1,828
			$O_{MB(2.5)} =$	1,974

1.6.8 In accordance with paragraph 5.2 of regulation 23, mean outflow values from the 0.0 m and -2.5 m tide conditions are combined in a 70%:30% ratio to obtain the bottom damage mean outflow:

$$O_{MB} = 0.7 O_{MB(0)} + 0.3 O_{MB(2.5)} \text{ (m}^3\text{)}$$

$$O_{MB} = (0.7)(1,544) + (0.3)(1,974) = 1,673 \text{ m}^3$$

1.7 Calculating the mean outflow parameter

1.7.1 In accordance with paragraph 5.1 of regulation 23, the mean outflow from side damage and bottom damage are combined in a 40%:60% ratio and then this value is divided by the total oil volume C to obtain the overall mean outflow parameter:

$$O_M = (0.4 O_{MS} + 0.6 O_{MB}) / C$$

$$O_M = [(0.4)(4,172) + (0.6)(1,673)] / 3,721 = 0.071$$

1.7.2 The final step in the evaluation of an actual oil tanker is to compare the calculated value of  $O_M$  with the maximum permissible value given in paragraph 3.1 of regulation 23.

## 2 VLCC example

### 2.1 General Data

L	:	321.10 m	(length as defined in regulation 1.19)
$d_s$	:	21.20 m	(moulded load line draught)
$d_B$	:	8.865 m	(moulded draught corresponding to 30% of the depth $D_s$ )
$B_s$	:	60.00 m	(the greatest moulded breadth at the deepest load line $d_s$ )
$B_B$	:	60.00 m	(the greatest moulded breadth at the waterline $d_B$ )
$D_s$	:	29.55 m	(moulded depth)
DW	:	300,000 ton	(deadweight as defined in regulation 1.23)
C	:	333,200 m <sup>3</sup>	(total volume of cargo oil at 98% tank filling)



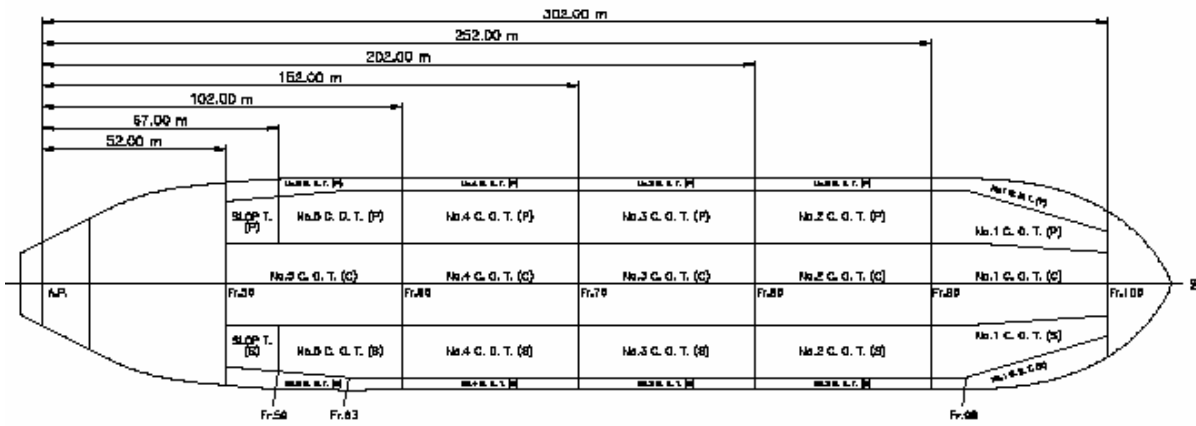


Figure 27 - Tank Arrangement

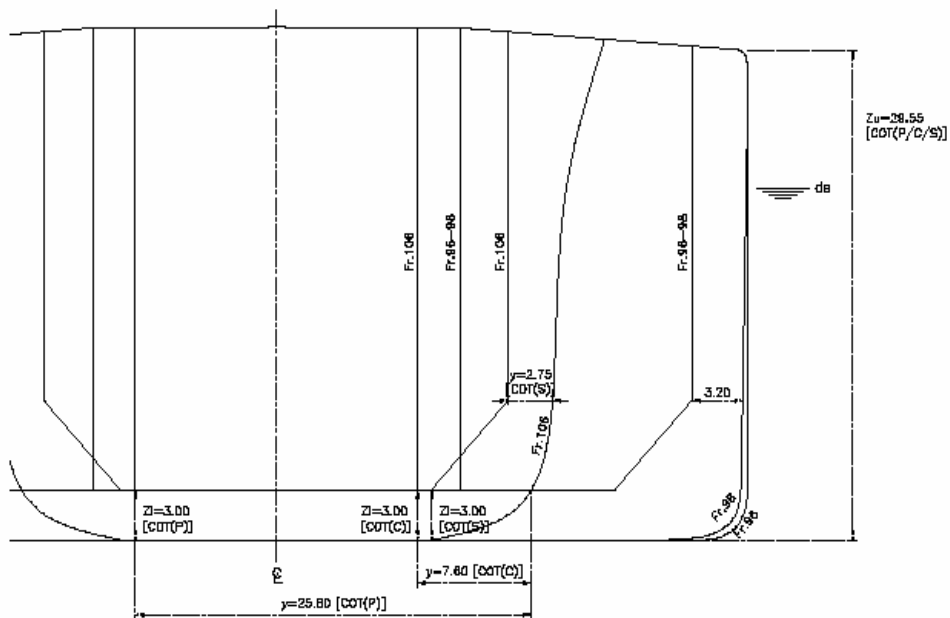


Figure 28 - Side Damage (No. 1 COT (Fr. 96 – Fr. 106))

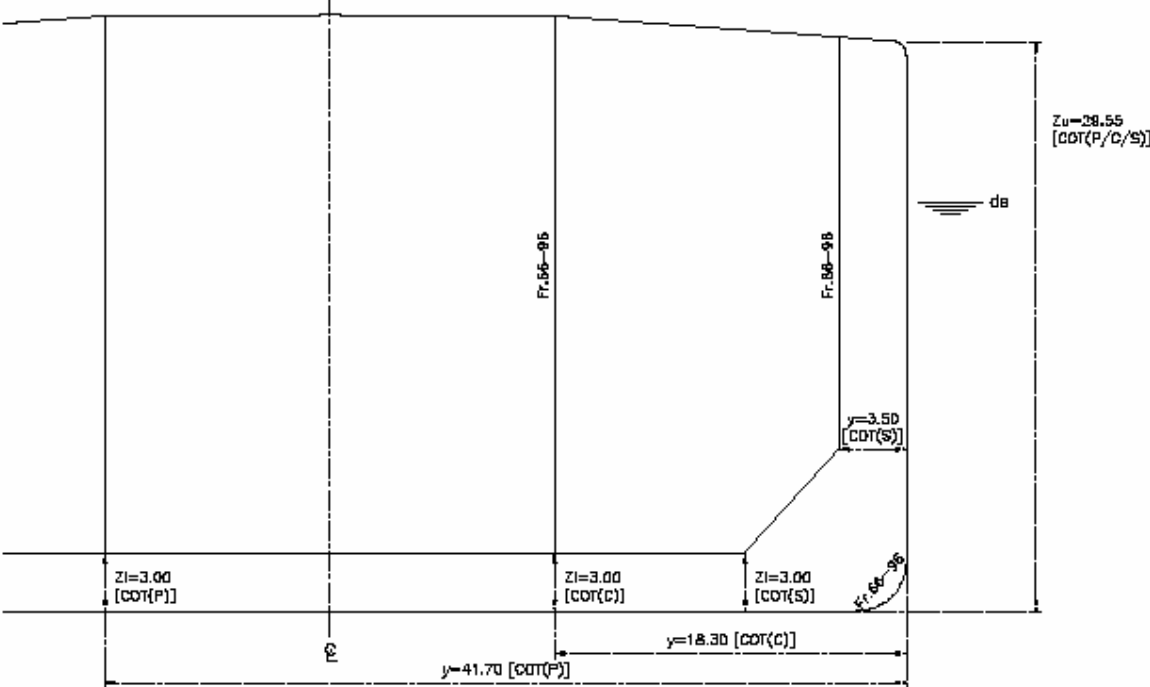


Figure 29 - Side Damage (Nos. 2,3,4 COT (Fr.66-Fr.96))

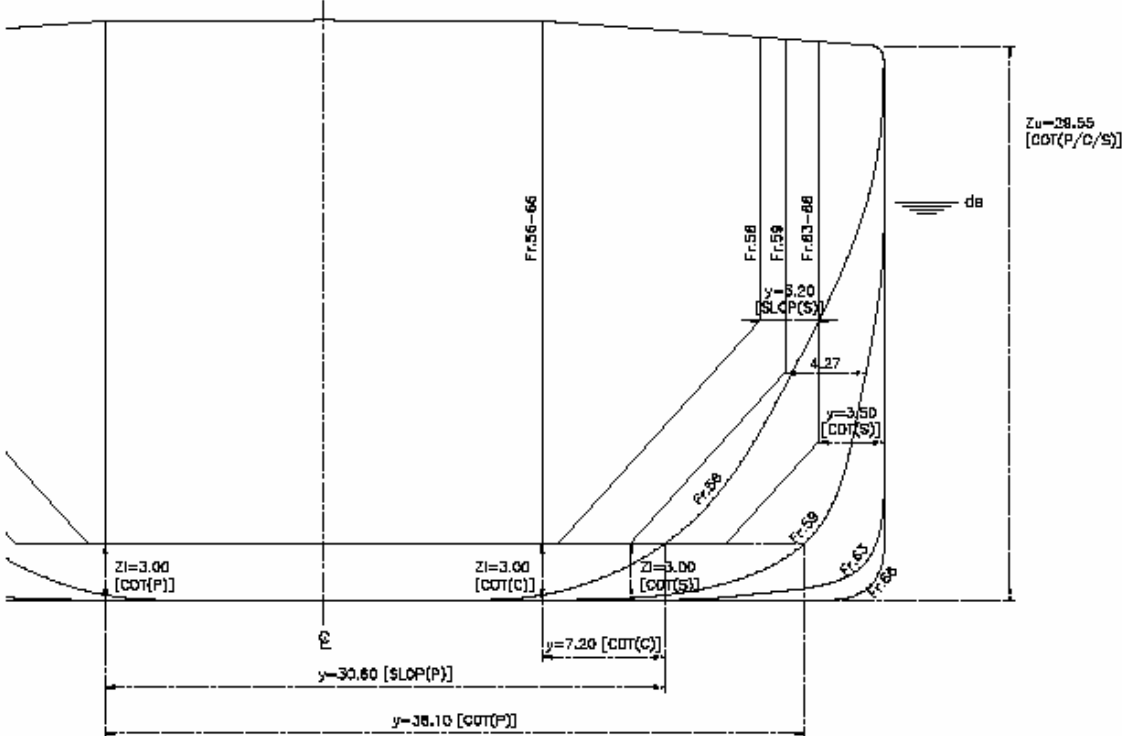


Figure 30 - Side Damage (No.5 COT & SLOP (Fr. 56-Fr.66))

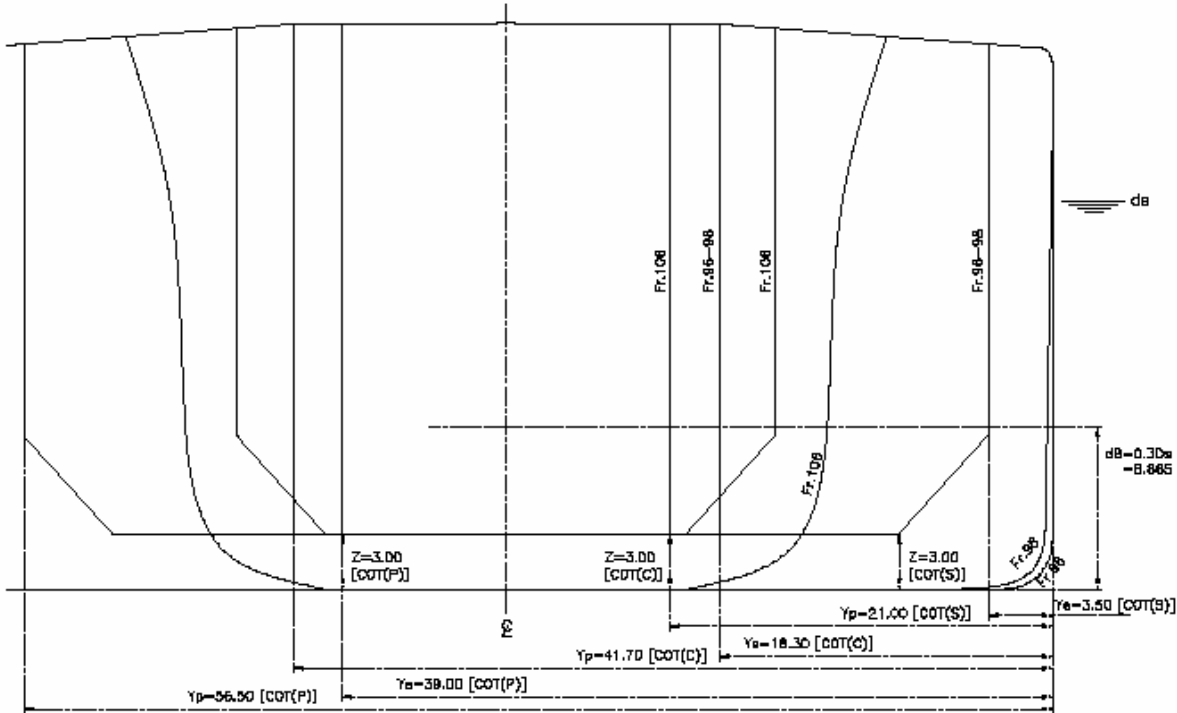


Figure 31 - Bottom Damage (No.1 COT (Fr. 96-Fr. 106))

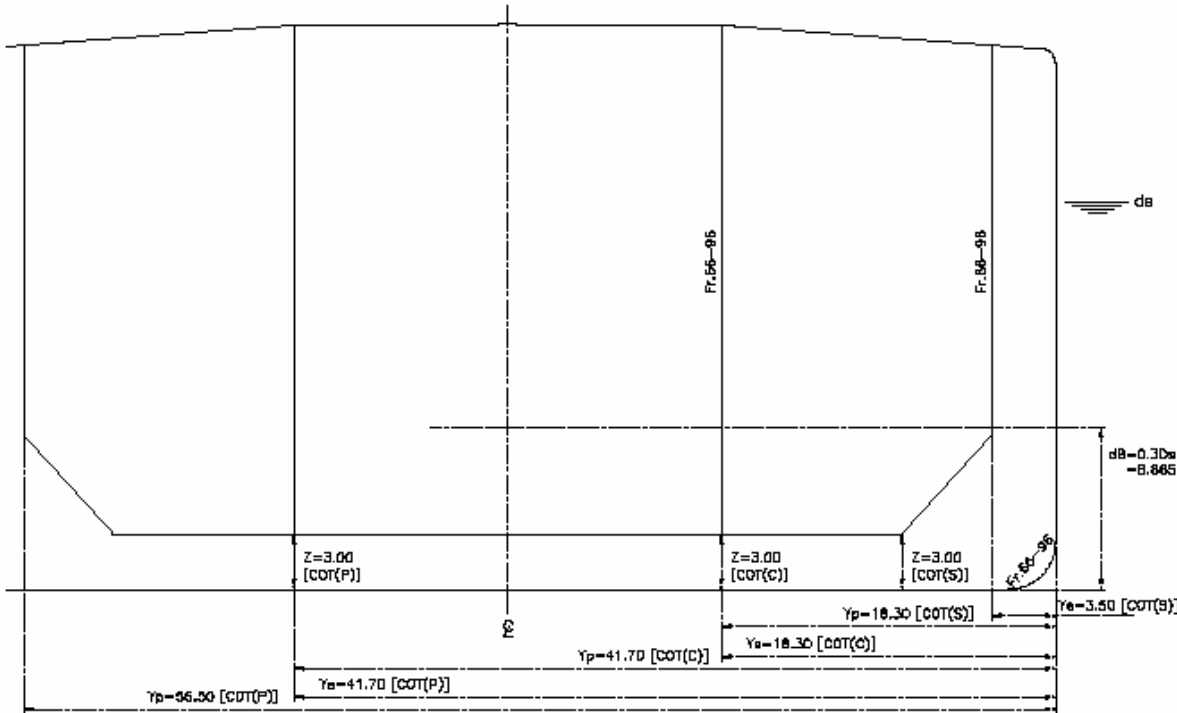


Figure 32 - Bottom Damage (Nos. 2,3,4 COT (Fr.66-Fr.96))

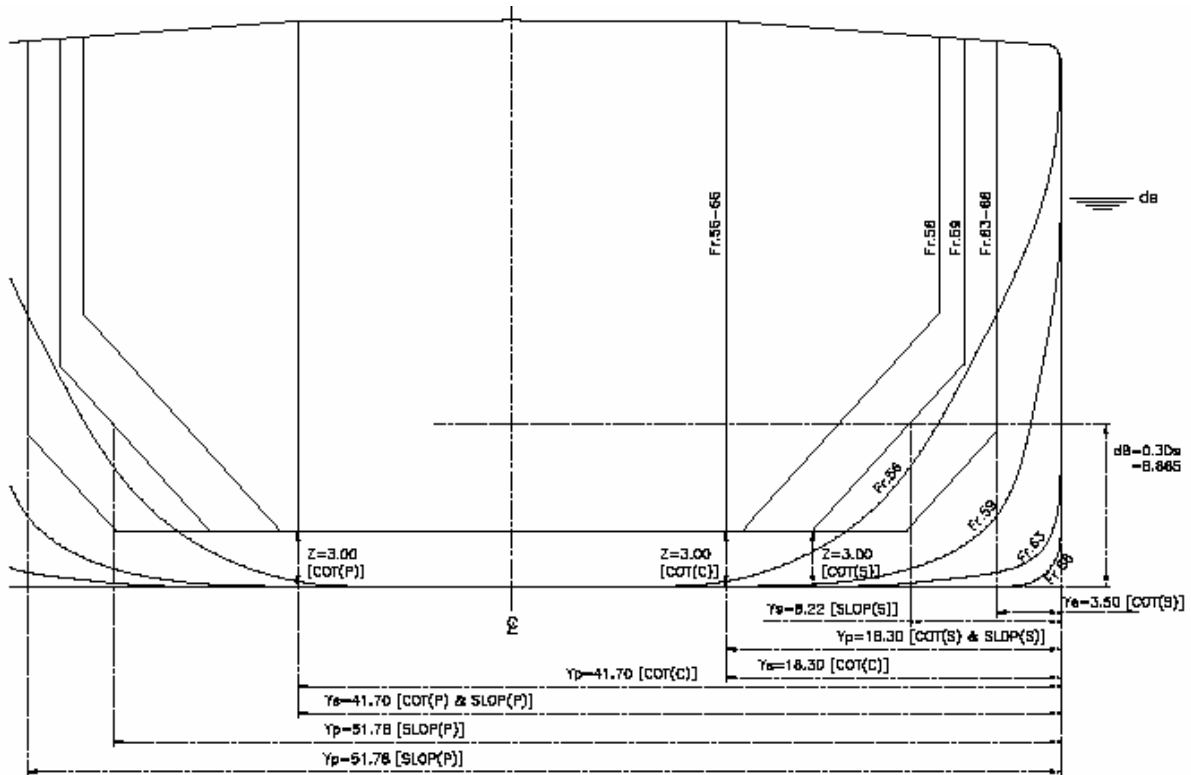


Figure 33 - Bottom Damage (No.5 & SLOP (Fr. 56- Fr.66))

## 2.2 Side damage outflow calculation

2.2.1 Each tank capacity and compartment boundaries  $X_a$ ,  $X_f$ ,  $Z_l$ ,  $Z_u$  and  $y$  are as follows:

Cargo Tank	98% Vol (m <sup>3</sup> )	$X_a$ (m)	$X_f$ (m)	$Z_l$ (m)	$Z_u$ (m)	$y$ (m)
No.1 C.O.T. (P)	14,372	252.000	302.000	3.000	29.550	25.600
No.1 C.O.T. (C)	28,890	252.000	302.000	3.000	29.550	7.600
No.1 C.O.T. (S)	14,372	252.000	302.000	3.000	29.550	2.750
No.2 C.O.T. (P)	19,081	202.000	252.000	3.000	29.550	41.700
No.2 C.O.T. (C)	31,821	202.000	252.000	3.000	29.550	18.300
No.2 C.O.T. (S)	19,081	202.000	252.000	3.000	29.550	3.500
No.3 C.O.T. (P)	19,081	152.000	202.000	3.000	29.550	41.700
No.3 C.O.T. (C)	31,821	152.000	202.000	3.000	29.550	18.300
No.3 C.O.T. (S)	19,081	152.000	202.000	3.000	29.550	3.500
No.4 C.O.T. (P)	19,081	102.000	152.000	3.000	29.550	41.700
No.4 C.O.T. (C)	31,821	102.000	152.000	3.000	29.550	18.300
No.4 C.O.T. (S)	19,081	102.000	152.000	3.000	29.550	3.500
No.5 C.O.T. (P)	12,681	67.000	102.000	3.000	29.550	38.100
No.5 C.O.T. (C)	31,821	52.000	102.000	3.000	29.550	7.200
No.5 C.O.T. (S)	12,681	67.000	102.000	3.000	29.550	3.500
Slop tank (P)	4,219	52.000	67.000	3.000	29.550	30.600
Slop tank (S)	4,219	52.000	67.000	3.000	29.550	3.200

2.2.2 The probability  $P_s$  of breaching a compartment from side damage is calculated in accordance with paragraph 8.1 of regulation 23:

$$P_s = P_{SL} P_{SV} P_{ST} \quad (2.2.2)$$

Where:

$$P_{SL} = 1 - P_{Sf} - P_{Sa}$$

$$P_{SV} = 1 - P_{Su} - P_{Sl}$$

$$P_{ST} = 1 - P_{Sy}$$

From the ratios  $X_a/L$ ,  $X_f/L$ ,  $Z/B_s$ ,  $Z/D_s$ ,  $Z_u/D_s$ ,  $Y/D_s$ , and  $y$ , the probabilities associated with these subdivision locations are interpolated from the table of probabilities for side damage provided in Paragraph 8.3 of regulation 23.

Cargo Tank	$X_a/L$	$P_{Sa}$	$X_f/L$	$P_{Sf}$	$Z/D_s$	$P_{Sl}$	$Z_u/D_s$	$P_{Su}$	$y/B_s$	$P_{Sy}$
No.1 C.O.T. (P)	0.7848	0.7518	0.9405	0.0315	0.1015	0.0011	1.0000	0.0000	0.4267	1.0000
No.1 C.O.T. (C)	0.7848	0.7518	0.9405	0.0315	0.1015	0.0011	1.0000	0.0000	0.1267	0.9029
No.1 C.O.T. (S)	0.7848	0.7518	0.9405	0.0315	0.1015	0.0011	1.0000	0.0000	0.0458	0.7247
No.2 C.O.T. (P)	0.6291	0.5961	0.7848	0.1822	0.1015	0.0011	1.0000	0.0000	0.6950	1.0000
No.2 C.O.T. (C)	0.6291	0.5961	0.7848	0.1822	0.1015	0.0011	1.0000	0.0000	0.3050	1.0000
No.2 C.O.T. (S)	0.6291	0.5961	0.7848	0.1822	0.1015	0.0011	1.0000	0.0000	0.0583	0.7876
No.3 C.O.T. (P)	0.4734	0.4404	0.6291	0.3379	0.1015	0.0011	1.0000	0.0000	0.6950	1.0000
No.3 C.O.T. (C)	0.4734	0.4404	0.6291	0.3379	0.1015	0.0011	1.0000	0.0000	0.3050	1.0000
No.3 C.O.T. (S)	0.4734	0.4404	0.6291	0.3379	0.1015	0.0011	1.0000	0.0000	0.0583	0.7876
No.4 C.O.T. (P)	0.3177	0.2847	0.4734	0.4936	0.1015	0.0011	1.0000	0.0000	0.6950	1.0000
No.4 C.O.T. (C)	0.3177	0.2847	0.4734	0.4936	0.1015	0.0011	1.0000	0.0000	0.3050	1.0000
No.4 C.O.T. (S)	0.3177	0.2847	0.4734	0.4936	0.1015	0.0011	1.0000	0.0000	0.0583	0.7876
No.5 C.O.T. (P)	0.2087	0.1757	0.3177	0.6493	0.1015	0.0011	1.0000	0.0000	0.6350	1.0000
No.5 C.O.T. (C)	0.1619	0.1289	0.3177	0.6493	0.1015	0.0011	1.0000	0.0000	0.1200	0.8992
No.5 C.O.T. (S)	0.2087	0.1757	0.3177	0.6493	0.1015	0.0011	1.0000	0.0000	0.0583	0.7876
Slop tank (P)	0.1619	0.1289	0.2087	0.7583	0.1015	0.0011	1.0000	0.0000	0.5100	1.0000
Slop tank (S)	0.1619	0.1289	0.2087	0.7583	0.1015	0.0011	1.0000	0.0000	0.0533	0.7652

Cargo Tank	$P_{SL}$	$P_{SV}$	$P_{ST}$	$P_s$
No.1 C.O.T. (P)	0.2167	0.9989	0.0000	0.0000
No.1 C.O.T. (C)	0.2167	0.9989	0.0971	0.0210
No.1 C.O.T. (S)	0.2167	0.9989	0.2753	0.0596
No.2 C.O.T. (P)	0.2217	0.9989	0.0000	0.0000
No.2 C.O.T. (C)	0.2217	0.9989	0.0000	0.0000
No.2 C.O.T. (S)	0.2217	0.9989	0.2124	0.0470
No.3 C.O.T. (P)	0.2217	0.9989	0.0000	0.0000
No.3 C.O.T. (C)	0.2217	0.9989	0.0000	0.0000
No.3 C.O.T. (S)	0.2217	0.9989	0.2124	0.0470
No.4 C.O.T. (P)	0.2217	0.9989	0.0000	0.0000
No.4 C.O.T. (C)	0.2217	0.9989	0.0000	0.0000
No.4 C.O.T. (S)	0.2217	0.9989	0.2124	0.0470
No.5 C.O.T. (P)	0.1750	0.9989	0.0000	0.0000
No.5 C.O.T. (C)	0.2217	0.9989	0.1008	0.0223
No.5 C.O.T. (S)	0.1750	0.9989	0.2124	0.0371
Slop tank (P)	0.1127	0.9989	0.0000	0.0000
Slop tank (S)	0.1127	0.9989	0.2348	0.0264

2.2.3 The mean outflow for side damage  $O_{MS}$  is calculated in accordance with paragraph 6 of regulation 23.

$$O_{MS} = C_3 \sum_i^n P_{s(i)} O_{s(i)} \text{ (m}^3\text{)} \quad (2.2.3-1)$$

$C_3 = 0.77$  for ships having two longitudinal bulkheads inside the cargo tanks extending over the length of the cargo block, and 1.0 for all other ships. In this case, there are two longitudinal bulkheads within the cargo tanks, and  $C_3 = 0.77$ .

Cargo Tank	$O_{s(i)}$	$(P_s)(O_{s(i)})$
No.1 C.O.T. (P)	14,371.7	0.0
No.1 C.O.T. (C)	28,890.4	606.9
No.1 C.O.T. (S)	14,371.7	856.3
No.2 C.O.T. (P)	19,080.6	0.0
No.2 C.O.T. (C)	31,820.6	0.0
No.2 C.O.T. (S)	19,080.6	897.7
No.3 C.O.T. (P)	19,080.6	0.0
No.3 C.O.T. (C)	31,820.6	0.0
No.3 C.O.T. (S)	19,080.6	897.7
No.4 C.O.T. (P)	19,080.6	0.0
No.4 C.O.T. (C)	31,820.6	0.0
No.4 C.O.T. (S)	19,080.6	897.7
No.5 C.O.T. (P)	12,681.2	0.0
No.5 C.O.T. (C)	31,820.6	710.4
No.5 C.O.T. (S)	12,681.2	470.9
Slop tank (P)	4,218.9	0.0
Slop tank (S)	4,218.9	111.5

$$\sum P_{s(i)} O_{s(i)} = 5,449 \text{ m}^3 \quad (2.2.3-2)$$

$$O_{MS} = 0.77 \times 5,449 \text{ m}^3 = \mathbf{4,195 \text{ m}^3} \quad (2.2.3-3)$$

## 2.3 Bottom damage outflow calculation

2.3.1 Compartment boundaries  $X_a$ ,  $X_f$ ,  $Y_p$ ,  $Y_s$  and  $z$  are taken as follows:

Cargo Tank	$X_a$ (m)	$X_f$ (m)	$Y_p$ (m)	$Y_s$ (m)	Z (m)
No.1 C.O.T. (P)	252.000	302.000	56.500	39.000	3.000
No.1 C.O.T. (C)	252.000	302.000	41.700	18.300	3.000
No.1 C.O.T. (S)	252.000	302.000	21.000	3.500	3.000
No.2 C.O.T. (P)	202.000	252.000	56.500	41.700	3.000
No.2 C.O.T. (C)	202.000	252.000	41.700	18.300	3.000
No.2 C.O.T. (S)	202.000	252.000	18.300	3.500	3.000
No.3 C.O.T. (P)	152.000	202.000	56.500	41.700	3.000
No.3 C.O.T. (C)	152.000	202.000	41.700	18.300	3.000
No.3 C.O.T. (S)	152.000	202.000	18.300	3.500	3.000
No.4 C.O.T. (P)	102.000	152.000	56.500	41.700	3.000
No.4 C.O.T. (C)	102.000	152.000	41.700	18.300	3.000
No.4 C.O.T. (S)	102.000	152.000	18.300	3.500	3.000
No.5 C.O.T. (P)	67.000	102.000	56.500	41.700	3.000
No.5 C.O.T. (C)	52.000	102.000	41.700	18.300	3.000
No.5 C.O.T. (S)	67.000	102.000	18.300	3.500	3.000
Slop tank (P)	52.000	67.000	51.780	41.700	3.000
Slop tank (S)	52.000	67.000	18.300	8.220	3.000

2.3.2 The probability  $P_B$  of breaching a compartment from bottom damage is calculated in accordance with paragraph 9.1 of regulation 23.

$$P_B = P_{BL} P_{BT} P_{BV} \quad (2.3.2)$$

Where,

$$P_{BL} = 1 - P_{Bf} - P_{Ba}$$

$$P_{BT} = 1 - P_{Bp} - P_{BS}$$

$$P_{BV} = 1 - P_{BZ}$$

2.3.3 From the ratios  $X_a/L$ ,  $X_f/L$ ,  $Y_p/B_B$ ,  $Y_s/B_B$ , and  $z$ , the probabilities associated with these subdivision locations are interpolated from the table of probabilities for bottom damage provided in paragraph 9.3 of regulation 23.

Cargo Tank	X <sub>a</sub> /L	P <sub>Ba</sub>	X <sub>f</sub> /L	P <sub>Bf</sub>	Y <sub>p</sub> /B <sub>B</sub>	P <sub>Bp</sub>	Y <sub>s</sub> /B <sub>B</sub>	P <sub>Bs</sub>	z/D <sub>s</sub>	P <sub>Bz</sub>
No.1 C.O.T. (P)	0.7848	0.3892	0.9405	0.0379	0.9417	0.0128	0.6500	0.4940	0.1015	0.7817
No.1 C.O.T. (C)	0.7848	0.3892	0.9405	0.0379	0.6950	0.1750	0.3050	0.1750	0.1015	0.7817
No.1 C.O.T. (S)	0.7848	0.3892	0.9405	0.0379	0.3500	0.4940	0.0583	0.0128	0.1015	0.7817
No.2 C.O.T. (P)	0.6291	0.2257	0.7848	0.2766	0.9417	0.0128	0.6950	0.5390	0.1015	0.7817
No.2 C.O.T. (C)	0.6291	0.2257	0.7848	0.2766	0.6950	0.1750	0.3050	0.1750	0.1015	0.7817
No.2 C.O.T. (S)	0.6291	0.2257	0.7848	0.2766	0.3050	0.5390	0.0583	0.0128	0.1015	0.7817
No.3 C.O.T. (P)	0.4734	0.1302	0.6291	0.5200	0.9417	0.0128	0.6950	0.5390	0.1015	0.7817
No.3 C.O.T. (C)	0.4734	0.1302	0.6291	0.5200	0.6950	0.1750	0.3050	0.1750	0.1015	0.7817
No.3 C.O.T. (S)	0.4734	0.1302	0.6291	0.5200	0.3050	0.5390	0.0583	0.0128	0.1015	0.7817
No.4 C.O.T. (P)	0.3177	0.0644	0.4734	0.7120	0.9417	0.0128	0.6950	0.5390	0.1015	0.7817
No.4 C.O.T. (C)	0.3177	0.0644	0.4734	0.7120	0.6950	0.1750	0.3050	0.1750	0.1015	0.7817
No.4 C.O.T. (S)	0.3177	0.0644	0.4734	0.7120	0.3050	0.5390	0.0583	0.0128	0.1015	0.7817
No.5 C.O.T. (P)	0.2087	0.0313	0.3177	0.8307	0.9417	0.0128	0.6950	0.5390	0.1015	0.7817
No.5 C.O.T. (C)	0.1619	0.0199	0.3177	0.8307	0.6950	0.1750	0.3050	0.1750	0.1015	0.7817
No.5 C.O.T. (S)	0.2087	0.0313	0.3177	0.8307	0.3050	0.5390	0.0583	0.0128	0.1015	0.7817
Slop tank (P)	0.1619	0.0199	0.2087	0.8898	0.8630	0.0549	0.6950	0.5390	0.1015	0.7817
Slop tank (S)	0.1619	0.0199	0.2087	0.8898	0.3050	0.5390	0.1370	0.0549	0.1015	0.7817

Cargo Tank	P <sub>BL</sub>	P <sub>BV</sub>	P <sub>BT</sub>	P <sub>B</sub>
No.1 C.O.T. (P)	0.5728	0.4932	0.2183	0.0617
No.1 C.O.T. (C)	0.5728	0.6500	0.2183	0.0813
No.1 C.O.T. (S)	0.5728	0.4932	0.2183	0.0617
No.2 C.O.T. (P)	0.4977	0.4482	0.2183	0.0487
No.2 C.O.T. (C)	0.4977	0.6500	0.2183	0.0706
No.2 C.O.T. (S)	0.4977	0.4482	0.2183	0.0487
No.3 C.O.T. (P)	0.3498	0.4482	0.2183	0.0342
No.3 C.O.T. (C)	0.3498	0.6500	0.2183	0.0496
No.3 C.O.T. (S)	0.3498	0.4482	0.2183	0.0342
No.4 C.O.T. (P)	0.2236	0.4482	0.2183	0.0219
No.4 C.O.T. (C)	0.2236	0.6500	0.2183	0.0317
No.4 C.O.T. (S)	0.2236	0.4482	0.2183	0.0219
No.5 C.O.T. (P)	0.1381	0.4482	0.2183	0.0135
No.5 C.O.T. (C)	0.1494	0.6500	0.2183	0.0212
No.5 C.O.T. (S)	0.1381	0.4482	0.2183	0.0135
Slop tank (P)	0.0903	0.4061	0.2183	0.0080
Slop tank (S)	0.0903	0.4061	0.2183	0.0080

2.3.4 Per paragraph 7.3.2 of regulation 23, the cargo level after damage, measured in metres above Z<sub>l</sub>, is calculated as follows:

$$h_c = \{(d_s + t_c - Z_l) (\rho_s) - (1000 p) / g\} / \rho_n \quad (2.3.4)$$

where:

d<sub>s</sub> = the load line draught = 21.20 m

t<sub>c</sub> = the tidal change = 0 m and -2.5 m

Z<sub>l</sub> = the height of the lowest point in the cargo tank above baseline = 3.0 m

ρ<sub>s</sub> = density of seawater, to be taken as 1,025 kg/m<sup>3</sup>

p = inert gas overpressure = 5 kPa

g = acceleration of gravity = 9.81 m/s<sup>2</sup>

ρ<sub>n</sub> = nominal density of cargo oil = 900 kg/m<sup>3</sup>



2.3.5 For the condition with the tidal change  $t_c$  equal to 0 m, the cargo level after damage  $h_c$  is 20.153 m. The remaining volume for each cargo tank after damage, in  $m^3$ , the oil outflow  $O_{B(i)}$  are as follows:

Cargo Tank	$h_c$ (m)	Remain Vol. ( $m^3$ )	$O_{B(i)}$ ( $m^3$ )
No.1 C.O.T. (P)	20.153	10,558	3813.7
No.1 C.O.T. (C)	20.153	21,267	7623.4
No.1 C.O.T. (S)	20.153	10,558	3813.7
No.2 C.O.T. (P)	20.153	14,163	4917.6
No.2 C.O.T. (C)	20.153	23,427	8393.6
No.2 C.O.T. (S)	20.153	14,163	4917.6
No.3 C.O.T. (P)	20.153	14,163	4917.6
No.3 C.O.T. (C)	20.153	23,427	8393.6
No.3 C.O.T. (S)	20.153	14,163	4917.6
No.4 C.O.T. (P)	20.153	14,163	4917.6
No.4 C.O.T. (C)	20.153	23,427	8393.6
No.4 C.O.T. (S)	20.153	14,163	4917.6
No.5 C.O.T. (P)	20.153	9,342	3339.2
No.5 C.O.T. (C)	20.153	23,427	8393.6
No.5 C.O.T. (S)	20.153	9,342	3339.2
Slop tank (P)	20.153	2,960	1258.9
Slop tank (S)	20.153	2,960	1258.9

For the condition with tidal change  $t_c$  equal to  $-2.5m$ , the remaining volume for each cargo tank after damage, in  $m^3$ , and the oil outflow  $O_{B(i)}$  is as follows:

Cargo Tank	$h_c$ (m)	Remain Vol. ( $m^3$ )	$O_{B(i)}$ ( $m^3$ )
No.1 C.O.T. (P)	17.307	8,974	5397.7
No.1 C.O.T. (C)	17.307	18,263	10627.4
No.1 C.O.T. (S)	17.307	8,974	5397.7
No.2 C.O.T. (P)	17.307	12,070	7010.6
No.2 C.O.T. (C)	17.307	20,119	11701.6
No.2 C.O.T. (S)	17.307	12,070	7010.6
No.3 C.O.T. (P)	17.307	12,070	7010.6
No.3 C.O.T. (C)	17.307	20,119	11701.6
No.3 C.O.T. (S)	17.307	12,070	7010.6
No.4 C.O.T. (P)	17.307	12,070	7010.6
No.4 C.O.T. (C)	17.307	20,119	11701.6
No.4 C.O.T. (S)	17.307	12,070	7010.6
No.5 C.O.T. (P)	17.307	7,926	4755.2
No.5 C.O.T. (C)	17.307	20,119	11701.6
No.5 C.O.T. (S)	17.307	7,926	4755.2
Slop tank (P)	17.307	2,436	1782.9
Slop tank (S)	17.307	2,436	1782.9

2.3.6 In accordance with paragraphs 7.1 and 7.2 of regulation 23, the mean outflow from bottom damage is calculated as follows:

$$O_{MB(0)} = \sum_i^n P_{B(i)} O_{B(i)} C_{DB(i)} \quad (m^3) \quad (2.3.6-1)$$

$$O_{MB(2.5)} = \sum_i^n P_{B(i)} O_{B(i)} C_{DB(i)} \quad (m^3) \quad (2.3.6-2)$$

2.3.7 It is recognized that a portion of the oil escaping from a cargo tank may be entrapped by a double bottom tank below, thereby preventing the oil from reaching the sea. In accordance with paragraph 7.4 of regulation 23,  $C_{DB(i)}$  is to be taken as 0.6 when a cargo tank is bounded from below by a non-oil compartment.

Cargo Tank	$C_{DB(i)}$	$P_{B(i)}$	$P_{B(i)}O_{B(i)}C_{DB(i)} (m^3)$ [ $t_c=0$ m]	$P_{B(i)}O_{B(i)}C_{DB(i)} (m^3)$ [ $t_c=-2.5$ m]
No.1 C.O.T. (P)	0.6	0.0617	141.1	199.7
No.1 C.O.T. (C)	0.6	0.0813	371.8	518.3
No.1 C.O.T. (S)	0.6	0.0617	141.1	199.7
No.2 C.O.T. (P)	0.6	0.0487	143.7	204.8
No.2 C.O.T. (C)	0.6	0.0706	355.7	495.9
No.2 C.O.T. (S)	0.6	0.0487	143.7	204.8
No.3 C.O.T. (P)	0.6	0.0342	101.0	144.0
No.3 C.O.T. (C)	0.6	0.0496	250.0	348.6
No.3 C.O.T. (S)	0.6	0.0342	101.0	144.0
No.4 C.O.T. (P)	0.6	0.0219	64.6	92.0
No.4 C.O.T. (C)	0.6	0.0317	159.8	222.8
No.4 C.O.T. (S)	0.6	0.0219	64.6	92.0
No.5 C.O.T. (P)	0.6	0.0135	27.1	38.5
No.5 C.O.T. (C)	0.6	0.0212	106.8	148.9
No.5 C.O.T. (S)	0.6	0.0135	27.1	38.5
Slop tank (P)	0.6	0.0080	6.0	8.6
Slop tank (S)	0.6	0.0080	6.0	8.6

$$\sum P_{B(i)} O_{B(i)} C_{DB(i)} \quad 2,211 \text{ m}^3 \quad 3,110 \text{ m}^3$$

2.3.8 In accordance with paragraph 5.2 of regulation 23, mean outflow values from the 0.0 m and -2.5 m tide conditions are combined in a 70%:30% ratio to obtain the bottom damage mean outflow:

$$\begin{aligned} O_{MB} &= 0.7 O_{MB(0)} + 0.3 O_{MB(2.5)} \\ &= 0.7 \times 2,211 + 0.3 \times 3,110 \\ &= \mathbf{2,481 \text{ m}^3} \end{aligned} \quad (2.3.8)$$

#### 2.4 Mean oil outflow parameter $O_M$

2.4.1 The non-dimensional mean oil outflow parameter  $O_M$  is calculated as follows in accordance with paragraph 5.1 of regulation 23.

$$\begin{aligned} O_M &= (0.4 O_{MS} + 0.6 O_{MB})/C \\ &= (0.4 \times 4,195 + 0.6 \times 2,481) / 333,200 = 0.0095 \end{aligned} \quad (2.4.1)$$

2.4.2 For oil tanker of 5,000 metric tons deadweight and above, the required mean oil outflow parameter is calculated in accordance with paragraph 3.1 of regulation 23.

$$\begin{array}{ll} O_M \leq 0.015 & \text{(for } C \leq 200,000 \text{ m}^3\text{)} \\ O_M \leq 0.012 + (0.003/200,000)(400,000 - C) & \text{(for } 200,000 \text{ m}^3 < C < 400,000 \text{ m}^3\text{)} \\ O_M \leq 0.012 & \text{(for } C \geq 400,000 \text{ m}^3\text{)} \end{array}$$

Since C is equal to 333,200 m<sup>3</sup>, the required mean oil outflow parameter O<sub>M</sub> is as follows.

$$\begin{array}{l} \text{Required } O_M \leq 0.012 + (0.003/200,000)(400,000 - 333,200) = 0.0130 \\ \text{Required } O_M, 0.0130 > \text{actual } O_M, 0.0095 \end{array}$$

The vessel is therefore in compliance with the “Accidental oil outflow performance” regulation 23.

#### REFERENCES

- (1) Report of the IMO Comparative Study on Oil Tanker Design (MEPC 32/7/15).
- (2) Statistical Analysis of Classification Society Records for Oil tanker Collisions and Groundings, Lloyds Register STD Report No. 2078-3-2.

\*\*\*

